



# 深圳市得著科技有限公司

## Touch Technology (Shenzhen) Co., Ltd.

### 公司介绍

深圳市得著科技有限公司是集研发、设计、制造、销售为一体的连接器、医疗仪器配件及耗材的精密现代化生产企业。主要产品有圆型插拔自锁各种系列连接器，高压连接器，气路快速接头，监护心电缆与导联线，血氧探头，体温探头等，并能提供专业的连接器及线束定制服务。产品广泛用于通讯、医疗、激光、汽车、测量测绘和检测、军工等仪器设备。得著研发团队专注精密圆形连接器及线束加工十多年历史，资金及技术力量雄厚，产品性能优越，质量可靠达到国际先进水平，（可）与国外知名品牌互换互用。产品远销欧美，印度，非洲等100多个国家，公司通过了ISO 9001-2008国际质量认证体系认证，美国UL 安全认证。公司始终秉承以诚信第一、客户至上的理念，建立了完整的用户服务体系。得著愿与您携手共铸美好未来！

### 公司质量管理体系

已通过ISO2008质量管理体系的认证.

### The Company Introduces:

Touch Technology(Shenzhen)Co.,Ltd is to gather development, design, make, sale is the conjunction machine, medical instrument accessories of integral whole and consume a material of precise modernization production business enterprise.

The main product has a type to put to pull out from the lock various series conjunction machine, the high pressure links a machine and annoys road to quickly deal with contact, serve as guardian heart electric cable with lead allied line, the blood oxygen stretches forward, the body temperature stretches forward etc., and can provide professional conjunction machine and line bunch to make to order service.

The product extensively useds for communication, medical treatment and laser, car and diagraph to survey and map and examines, soldier work etc. instrument equipments.

Get Zhao development the team devote one's mind precise circular to connect machine with a line bunch to process more than ten calendars history, funds and technique strength strong, product function superior, the quality credibility attains international advanced level (can)and changes to use with each other with each other with foreign well-known brand.The product far sells Europe and America, India, more than 100 nations like Africa,etc, the company passed ISO 9001-2008 international quality attestation system attestations, UL the United States safe attestation.The company always multiplies by with the principle of trustworthiness the first, customer's supremacy and built up service system of the customer of integrity.Get the Zhao wish to hold hands with you total Zhu for fine future!

### The Company Quality Manages System:

The ISO2008 qualities manage the attestation of system.



## 产品目录 (PRODUCTION)

1. 直插式脉搏血氧饱和度探头	1
Direct Reusable Spo2 Sensor	
2. 血氧转接线	15
Spo2 Sensor Extension cable	
3. 一次性脉搏血氧饱和度探头	22
Disposable Spo2 Sensor cable	
4. 一体式监护心电电缆和导联线	26
One-Piece Series Patient Cable With Leads	
5. 分体式监护心电电缆和导联线	37
Two-Piece Series Patient Cable With Leads	
6. 一体式心电图仪心电电缆和导联线	48
One-Piece Series EKG Cable With Leads	
7. 分体式心电图仪电缆与导联线	57
EKG Trunk Cable With Leadswires	
8. 动态心电电缆与导联线	61
Holter Recorder ECG Patient Cable and leads	
9. 有创血压传感器	70
Invasive Pressure Transducers cable	
10. 医用温度探头	76
Medical Temperature probe	
11. 无创血压袖带	80
NON Invasive Blood Pressure CUFF	
12. 连接管	83
Tubes	
13. 心电电极	87
ECG Electrodes	
14. 高频电刀笔与连接线	89
ESU pencil Connecting cable for electrosurgery	



# 直插式脉搏血氧饱和度探头

## Direct Reusable Spo2 Sensor

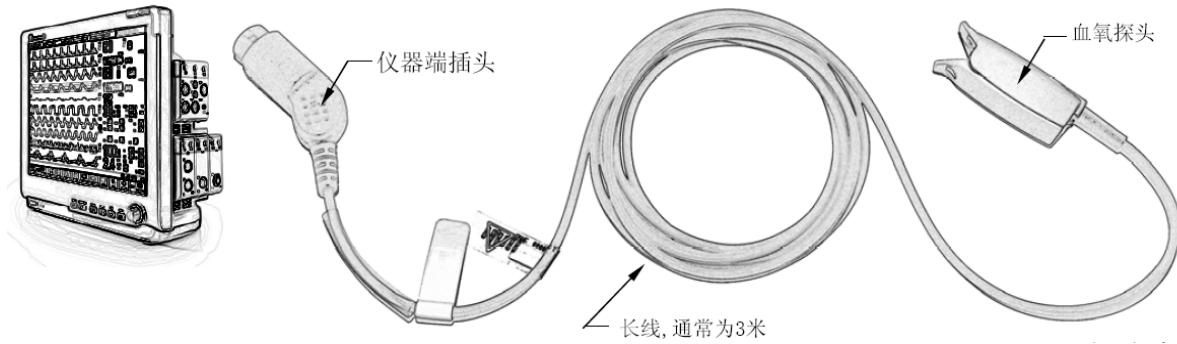

### 探头端:

新生儿包裹式脉搏血氧饱和度探头  
适用于: 1-4kg的新生儿, 3-15kg婴儿



儿童指夹式脉搏血氧饱和度探头  
适用于: 10-40kg的儿童



儿童软指套脉搏血氧饱和度探头  
适用于: 10-40kg的儿童



成人指夹式脉搏血氧饱和度探头  
适用于: >40kg的成人



成人软指套脉搏血氧饱和度探头  
适用于: >40kg的成人



成人耳夹式脉搏血氧饱和度探头  
适用于: >40kg的成人

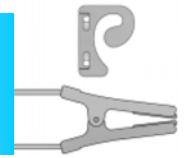



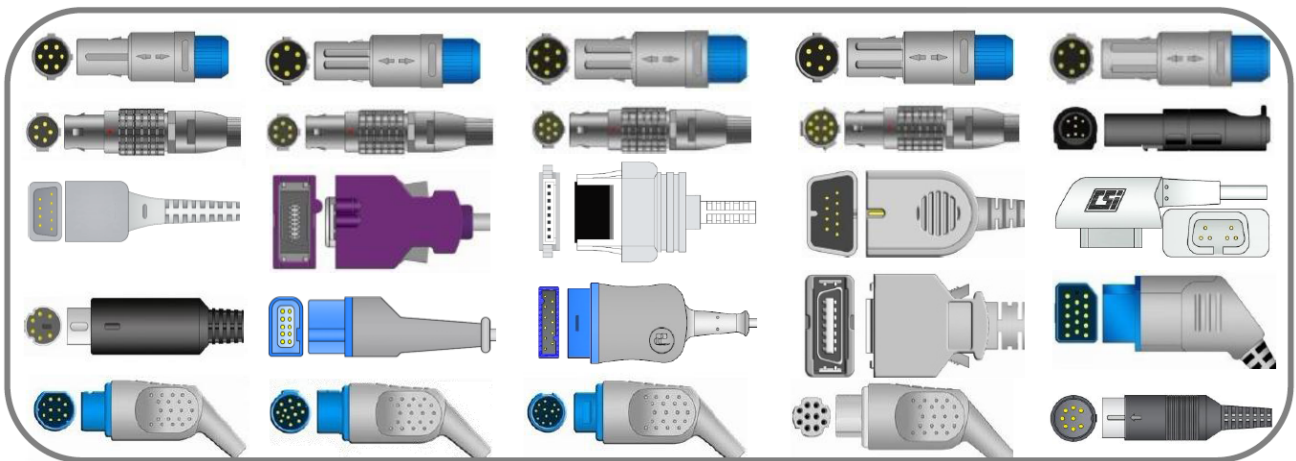

### 设备端连接器:





# 直插式脉搏血氧饱和度探头

## Direct Reusable Spo2 Sensor

兼容品牌 Manufacturer	产品编号 P/N	产品描述 Product description	兼容型号 Compatibility	仪器端插头 Interface	产品长度 Length
BCI	SP-001	新生儿包裹式 Neonate silicone Wrap	BCI:3100, 3101, 3300, 3301, 3302, 3303, 3304. 3401, 6100, 9100, MiniTorr.		1.0m/3.0m
	SP-002	儿童指夹式 Pediatric finger clip			1.0m/3.0m
	SP-003	儿童软指套式 Pediatric silicone soft tip			1.0m/3.0m
	SP-004	成人指夹式 Adult finger clip			1.0m/3.0m
	SP-005	成人软指套 Adult silicone soft tip			1.0m/3.0m
	SP-006	成人耳夹式 Adult ear clip probe			1.0m/3.0m
	SP-007	新生儿包裹式 Neonate silicone Wrap	BCI:6100, 9100 Advospr. Aitpcpr, MiniTorr, MiniTorr Plus		3.0m
	SP-008	儿童指夹式 Pediatric finger clip			3.0m
	SP-009	儿童软指套式 Pediatric silicone soft tip			3.0m
	SP-010	成人指夹式 Adult finger clip			3.0m
	SP-011	成人软指套 Adult silicone soft tip			3.0m
	SP-012	成人耳夹式 Adult ear clip probe			3.0m
BIONET	SP-013	新生儿包裹式 Neonate silicone Wrap	BIONET:BM3		3.0m
	SP-014	儿童指夹式 Pediatric finger clip			3.0m
	SP-015	儿童软指套式 Pediatric silicone soft tip			3.0m
	SP-016	成人指夹式 Adult finger clip			3.0m
	SP-017	成人软指套 Adult silicone soft tip			3.0m
	SP-018	成人耳夹式 Adult ear clip probe			3.0m
	SP-019	新生儿包裹式 Neonate silicone Wrap	BIONET:BM3, BM3 PLUS		3.0m
	SP-020	儿童指夹式 Pediatric finger clip			3.0m
	SP-021	儿童软指套式 Pediatric silicone soft tip			3.0m
	SP-022	成人指夹式 Adult finger clip			3.0m
	SP-023	成人软指套 Adult silicone soft tip			3.0m
	SP-024	成人耳夹式 Adult ear clip probe			3.0m





本公司所有网站, 彩页所涉及到的图片, 文件, 商标, 版权均属于原作者, 本处出于产品说明需要而引用, 绝无它用

公司官方网站 : <http://www.touch-sz.com>



# 直插式脉搏血氧饱和度探头

## Direct Reusable Spo2 Sensor

兼容品牌 Manufacturer	产品编号 P/N	产品描述 Product description	兼容型号 Compatibility	仪器端插头 Interface	产品长度 Length
BIONET	SP-025	新生儿包裹式 Neonate silicone Wrap	BIONET:BM3		1.0m
	SP-026	儿童指夹式 Pediatric finger clip			1.0m
	SP-027	儿童软指套式 Pediatric silicone soft tip			1.0m
	SP-028	成人指夹式 Adult finger clip			1.0m
	SP-029	成人软指套 Adult silicone soft tip			1.0m
	SP-030	成人耳夹式 Adult ear clip probe			1.0m
BIOSYS	SP-031	新生儿包裹式 Neonate silicone Wrap	BIOSYS:BPM300		3.0m
	SP-032	儿童指夹式 Pediatric finger clip			3.0m
	SP-033	儿童软指套式 Pediatric silicone soft tip			3.0m
	SP-034	成人指夹式 Adult finger clip			3.0m
	SP-035	成人软指套 Adult silicone soft tip			3.0m
	SP-036	成人耳夹式 Adult ear clip probe			3.0m
布鲁克 BRUKER	SP-037	新生儿包裹式 Neonate silicone Wrap	Bruker (Odam) all as DC-3002, IH, M3		3.0m
	SP-038	儿童指夹式 Pediatric finger clip			3.0m
	SP-039	儿童软指套式 Pediatric silicone soft tip			3.0m
	SP-040	成人指夹式 Adult finger clip			3.0m
	SP-041	成人软指套 Adult silicone soft tip			3.0m
	SP-042	成人耳夹式 Adult ear clip probe			3.0m
CSI	SP-043	新生儿包裹式 Neonate silicone Wrap	CSI: shoolar, poet (602- 3A); 1100, 581, 508 , 507, 507SD, 504, 5 03, 501		3.0m
	SP-044	儿童指夹式 Pediatric finger clip			3.0m
	SP-045	儿童软指套式 Pediatric silicone soft tip			3.0m
	SP-046	成人指夹式 Adult finger clip			3.0m
	SP-047	成人软指套 Adult silicone soft tip			3.0m
	SP-048	成人耳夹式 Adult ear clip probe			3.0m



本公司所有网站, 彩页所涉及到的图片, 文件, 商标, 版权均属于原作者, 本处出于产品说明需要而引用, 绝无它用

公司官方网站 : <http://www.touch-sz.com>



# 直插式脉搏血氧饱和度探头

## Direct Reusable Spo2 Sensor

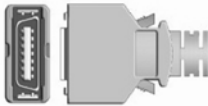
兼容品牌 Manufacturer	产品编号 P/N	产品描述 Product description	兼容型号 Compatibility	仪器端插头 Interface	产品长度 Length
CSI	SP-049	新生儿包裹式 Neonate silicone Wrap	CSI:503DX, 503spo t, 504DX, 506DX, 50 7ELC2 scholar1III, 8100 poet plus		1.0m/3.0m
	SP-050	儿童指夹式 Pediatric finger clip			1.0m/3.0m
	SP-051	儿童软指套式 Pediatric silicone soft tip			1.0m/3.0m
	SP-052	成人指夹式 Adult finger clip			1.0m/3.0m
	SP-053	成人软指套 Adult silicone soft tip			1.0m/3.0m
	SP-054	成人耳夹式 Adult ear clip probe			1.0m/3.0m
德恩 DATEX	SP-055	新生儿包裹式 Neonate silicone Wrap	Datex- Ohmeda:3740, 3710 , 4700 OxiCap, 5250RGM Biox 3760, ohmeda 3770, 3775, Rascal II		3.0m
	SP-056	儿童指夹式 Pediatric finger clip			3.0m
	SP-057	儿童软指套式 Pediatric silicone soft tip			3.0m
	SP-058	成人指夹式 Adult finger clip			3.0m
	SP-059	成人软指套 Adult silicone soft tip			3.0m
	SP-060	成人耳夹式 Adult ear clip probe			3.0m
德恩 DATEX	SP-061	新生儿包裹式 Neonate silicone Wrap	Datex:AS/3. CS/3, CH /S, CH/2S, CH- RSCG/2S, Cardiocap I, Capnomac Uitima, Light Monitor, M- Estpr, Oscar II, OSP-200, Satlite Trans, Satlite Trans Plus		1.0m
	SP-062	儿童指夹式 Pediatric finger clip			1.0m
	SP-063	儿童软指套式 Pediatric silicone soft tip			1.0m
	SP-064	成人指夹式 Adult finger clip			1.0m
	SP-065	成人软指套 Adult silicone soft tip			1.0m
	SP-066	成人耳夹式 Adult ear clip probe			1.0m
海豚 DOLPHIN (OSI)	SP-067	新生儿包裹式 Neonate silicone Wrap	Dolphin ONE Oximeters 2100, 2150 compatible for:2G00751		1.0m/3.0m
	SP-068	儿童指夹式 Pediatric finger clip			1.0m/3.0m
	SP-069	儿童软指套式 Pediatric silicone soft tip			1.0m/3.0m
	SP-070	成人指夹式 Adult finger clip			1.0m/3.0m
	SP-071	成人软指套 Adult silicone soft tip			1.0m/3.0m
	SP-072	成人耳夹式 Adult ear clip probe			1.0m/3.0m





本公司所有网站, 彩页所涉及到的图片, 文件, 商标, 版权均属于原作者, 本处出于产品说明需要而引用, 绝无它用

公司官方网站 : <http://www.touch-sz.com>



# 直插式脉搏血氧饱和度探头

## Direct Reusable Spo2 Sensor

兼容品牌 Manufacturer	产品编号 P/N	产品描述 Product description	兼容型号 Compatibility	仪器端插头 Interface	产品长度 Length
德尔格 DRAGER	SP-073	新生儿包裹式 Neonate silicone Wrap	Dolphin ONE Oximeters 2100, 2150 compatible for:2G00751		3.0m
	SP-074	儿童指夹式 Pediatric finger clip			3.0m
	SP-075	儿童软指套式 Pediatric silicone soft tip			3.0m
	SP-076	成人指夹式 Adult finger clip			3.0m
	SP-077	成人软指套 Adult silicone soft tip			3.0m
	SP-078	成人耳夹式 Adult ear clip probe			3.0m
通用医疗-马 葵 GE-MARQUETTE (NELLCOR模 块)	SP-079	新生儿包裹式 Neonate silicone Wrap	GE Medical Systems:ALL nellcor mould		3.0m
	SP-080	儿童指夹式 Pediatric finger clip			3.0m
	SP-081	儿童软指套式 Pediatric silicone soft tip			3.0m
	SP-082	成人指夹式 Adult finger clip			3.0m
	SP-083	成人软指套 Adult silicone soft tip			3.0m
	SP-084	成人耳夹式 Adult ear clip probe			3.0m
通用医疗-马 葵 GE-MARQUETTE (MASIMO模块)	SP-085	新生儿包裹式 Neonate silicone Wrap	GE Medical Systems:ALL masimo mould		3.0m
	SP-086	儿童指夹式 Pediatric finger clip			3.0m
	SP-087	儿童软指套式 Pediatric silicone soft tip			3.0m
	SP-088	成人指夹式 Adult finger clip			3.0m
	SP-089	成人软指套 Adult silicone soft tip			3.0m
	SP-090	成人耳夹式 Adult ear clip probe			3.0m
通用医疗-马 葵 GE-MARQUETTE (OXIMAX模块)	SP-091	新生儿包裹式 Neonate silicone Wrap	GE Medical Systems:ALL nellcor oximax mould		3.0m
	SP-092	儿童指夹式 Pediatric finger clip			3.0m
	SP-093	儿童软指套式 Pediatric silicone soft tip			3.0m
	SP-094	成人指夹式 Adult finger clip			3.0m
	SP-095	成人软指套 Adult silicone soft tip			3.0m
	SP-096	成人耳夹式 Adult ear clip probe			3.0m

本公司所有网站, 彩页所涉及到的图片, 文件, 商标, 版权均属于原作者, 本处出于产品说明需要而引用, 绝无它用

公司官方网站 : <http://www.touch-sz.com>



# 直插式脉搏血氧饱和度探头

## Direct Reusable Spo2 Sensor

兼容品牌 Manufacturer	产品编号 P/N	产品描述 Product description	兼容型号 Compatibility	仪器端插头 Interface	产品长度 Length
通用医疗-欧 美达 GE-OHMEDA	SP-097	新生儿包裹式 Neonate silicone Wrap	Sensor solutions for GE Ohmeda Trusat pulse oximeter		3.0m
	SP-098	儿童指夹式 Pediatric finger clip			3.0m
	SP-099	儿童软指套式 Pediatric silicone soft tip			3.0m
	SP-100	成人指夹式 Adult finger clip			3.0m
	SP-101	成人软指套 Adult silicone soft tip			3.0m
	SP-102	成人耳夹式 Adult ear clip probe			3.0m
马斯莫 MASIMO	SP-103	新生儿包裹式 Neonate silicone Wrap	GE:PR01000, V300 INVIVO:T8 Schiller, ZOLL, Masimo Datascope:Trio, Pas sport 2, Spectrum		3.0m
	SP-104	儿童指夹式 Pediatric finger clip			3.0m
	SP-105	儿童软指套式 Pediatric silicone soft tip			3.0m
	SP-106	成人指夹式 Adult finger clip			3.0m
	SP-107	成人软指套 Adult silicone soft tip			3.0m
	SP-108	成人耳夹式 Adult ear clip probe			3.0m
马斯莫 MASIMO	SP-109	新生儿包裹式 Neonate silicone Wrap	原装		1.0m
	SP-110	儿童指夹式 Pediatric finger clip			1.0m
	SP-111	儿童软指套式 Pediatric silicone soft tip			1.0m
	SP-112	成人指夹式 Adult finger clip			1.0m
	SP-113	成人软指套 Adult silicone soft tip			1.0m
	SP-114	成人耳夹式 Adult ear clip probe			1.0m
杰纳瑞 GMI	SP-115	新生儿包裹式 Neonate silicone Wrap	G2A Vital. slgns MARLTOR G3D, G3A, G3C, G3F, G3 G, G3G Patient monitor		3.0m
	SP-116	儿童指夹式 Pediatric finger clip			3.0m
	SP-117	儿童软指套式 Pediatric silicone soft tip			3.0m
	SP-118	成人指夹式 Adult finger clip			3.0m
	SP-119	成人软指套 Adult silicone soft tip			3.0m
	SP-120	成人耳夹式 Adult ear clip probe			3.0m

本公司所有网站, 彩页所涉及到的图片, 文件, 商标, 版权均属于原作者, 本处出于产品说明需要而引用, 绝无它用





公司官方网站 : <http://www.touch-sz.com>





# 直插式脉搏血氧饱和度探头

## Direct Reusable Spo2 Sensor

兼容品牌 Manufacturer	产品编号 P/N	产品描述 Product description	兼容型号 Compatibility	仪器端插头 Interface	产品长度 Length
美克 MEK	SP-121	新生儿包裹式 Neonate silicone Wrap	MEK:MP-100, MP110, MP400, MP500, MP600, MP1000		1.0m/3.0m
	SP-122	儿童指夹式 Pediatric finger clip			1.0m/3.0m
	SP-123	儿童软指套式 Pediatric silicone soft tip			1.0m/3.0m
	SP-124	成人指夹式 Adult finger clip			1.0m/3.0m
	SP-125	成人软指套 Adult silicone soft tip			1.0m/3.0m
	SP-126	成人耳夹式 Adult ear clip probe			1.0m/3.0m
康强 KONTRON	SP-127	新生儿包裹式 Neonate silicone Wrap	KONTRON:7840, 7845 Minimon7137, kolormon, Micromon, Supermon, Trakmon		3.0m
	SP-128	儿童指夹式 Pediatric finger clip			3.0m
	SP-129	儿童软指套式 Pediatric silicone soft tip			3.0m
	SP-130	成人指夹式 Adult finger clip			3.0m
	SP-131	成人软指套 Adult silicone soft tip			3.0m
	SP-132	成人耳夹式 Adult ear clip probe			3.0m
迈瑞 MINDRAY	SP-133	新生儿包裹式 Neonate silicone Wrap	Mindray:PM9000*(BC I module)		3.0m
	SP-134	儿童指夹式 Pediatric finger clip			3.0m
	SP-135	儿童软指套式 Pediatric silicone soft tip			3.0m
	SP-136	成人指夹式 Adult finger clip			3.0m
	SP-137	成人软指套 Adult silicone soft tip			3.0m
	SP-138	成人耳夹式 Adult ear clip probe			3.0m
迈瑞 MINDRAY	SP-139	新生儿包裹式 Neonate silicone Wrap	Mindray:PM7000, 6201, 8000, 9000 Kontron:7138, 7840, 7845 科瑞 康:PC9000, UP6000 ChaoLide, GOLDWAY, Qilan邦健1BM9000	塑料插头 40° 	3.0m
	SP-140	儿童指夹式 Pediatric finger clip			3.0m
	SP-141	儿童软指套式 Pediatric silicone soft tip			3.0m
	SP-142	成人指夹式 Adult finger clip			3.0m
	SP-143	成人软指套 Adult silicone soft tip			3.0m
	SP-144	成人耳夹式 Adult ear clip probe			3.0m





本公司所有网站, 彩页所涉及到的图片, 文件, 商标, 版权均属于原作者, 本处出于产品说明需要而引用, 绝无它用

公司官方网站 :<http://www.touch-sz.com>



# 直插式脉搏血氧饱和度探头

## Direct Reusable Spo2 Sensor

兼容品牌 Manufacturer	产品编号 P/N	产品描述 Product description	兼容型号 Compatibility	仪器端插头 Interface	产品长度 Length
迈瑞 MINDRAY	SP-145	新生儿包裹式 Neonate silicone Wrap	Mindray:PM5000, PM6000	塑料插头 40° 	3.0m
	SP-146	儿童指夹式 Pediatric finger clip			3.0m
	SP-147	儿童软指套式 Pediatric silicone soft tip			3.0m
	SP-148	成人指夹式 Adult finger clip			3.0m
	SP-149	成人软指套 Adult silicone soft tip			3.0m
	SP-150	成人耳夹式 Adult ear clip probe			3.0m
迈瑞 MINDRAY (MASIM MODULE)	SP-151	新生儿包裹式 Neonate silicone Wrap	Mindray:PM5000, PM6000		3.0m
	SP-152	儿童指夹式 Pediatric finger clip			3.0m
	SP-153	儿童软指套式 Pediatric silicone soft tip			3.0m
	SP-154	成人指夹式 Adult finger clip			3.0m
	SP-155	成人软指套 Adult silicone soft tip			3.0m
	SP-156	成人耳夹式 Adult ear clip probe			3.0m
迈瑞 MINDRAY (MASIM MODULE)	SP-157	新生儿包裹式 Neonate silicone Wrap	Mindray:MEL-509, 509+, 503, 507		3.0m
	SP-158	儿童指夹式 Pediatric finger clip			3.0m
	SP-159	儿童软指套式 Pediatric silicone soft tip			3.0m
	SP-160	成人指夹式 Adult finger clip			3.0m
	SP-161	成人软指套 Adult silicone soft tip			3.0m
	SP-162	成人耳夹式 Adult ear clip probe			3.0m
迈瑞 MINDRAY	SP-163	新生儿包裹式 Neonate silicone Wrap	Mindray:VS-800	塑料插头 80° 	3.0m
	SP-164	儿童指夹式 Pediatric finger clip			3.0m
	SP-165	儿童软指套式 Pediatric silicone soft tip			3.0m
	SP-166	成人指夹式 Adult finger clip			3.0m
	SP-167	成人软指套 Adult silicone soft tip			3.0m
	SP-168	成人耳夹式 Adult ear clip probe			3.0m



本公司所有网站, 彩页所涉及到的图片, 文件, 商标, 版权均属于原作者, 本处出于产品说明需要而引用, 绝无它用

公司官方网站 : <http://www.touch-sz.com>



# 直插式脉搏血氧饱和度探头

## Direct Reusable Spo2 Sensor

兼容品牌 Manufacturer	产品编号 P/N	产品描述 Product description	兼容型号 Compatibility	仪器端插头 Interface	产品长度 Length
奈普特 (NELLCOR)	SP-169	新生儿包裹式 Neonate silicone Wrap	Nellcor:N180, N6000, N190, N20, NPB40, N100, N200 Corometrics:120, 510, 511, 118, 188, 129, 129F, 128 COLIN:BP88, 306, 508, 808, 885 Datascope (S&W) :Pasport, XG DimaLItalia:all		3.0m
	SP-170	儿童指夹式 Pediatric finger clip			3.0m
	SP-171	儿童软指套式 Pediatric silicone soft tip			3.0m
	SP-172	成人指夹式 Adult finger clip			3.0m
	SP-173	成人软指套 Adult silicone soft tip			3.0m
	SP-174	成人耳夹式 Adult ear clip probe			3.0m
奈普特 (NELLCOR)	SP-175	新生儿包裹式 Neonate silicone Wrap	OXI TECH 550, N595, N560		1.0m
	SP-176	儿童指夹式 Pediatric finger clip			1.0m
	SP-177	儿童软指套式 Pediatric silicone soft tip			1.0m
	SP-178	成人指夹式 Adult finger clip			1.0m
	SP-179	成人软指套 Adult silicone soft tip			1.0m
	SP-180	成人耳夹式 Adult ear clip probe			1.0m
奈普特 (NELLCOR)	SP-181	新生儿包裹式 Neonate silicone Wrap	Nellcor 血氧 仪:ALL; GE Dash系列OXIMAX 血氧模块的血氧 仪:Dash1800, Dash2500, Dash300;		3.0m
	SP-182	儿童指夹式 Pediatric finger clip			3.0m
	SP-183	儿童软指套式 Pediatric silicone soft tip			3.0m
	SP-184	成人指夹式 Adult finger clip			3.0m
	SP-185	成人软指套 Adult silicone soft tip			3.0m
	SP-186	成人耳夹式 Adult ear clip probe			3.0m
奈普特 (NELLCOR)	SP-187	新生儿包裹式 Neonate silicone Wrap	Nellcor 血氧 仪:ALL; GE Dash系列OXIMAX 血氧模块的血氧 仪:Dash1800, Dash2500, Dash300;		1.0m
	SP-188	儿童指夹式 Pediatric finger clip			1.0m
	SP-189	儿童软指套式 Pediatric silicone soft tip			1.0m
	SP-190	成人指夹式 Adult finger clip			1.0m
	SP-191	成人软指套 Adult silicone soft tip			1.0m
	SP-192	成人耳夹式 Adult ear clip probe			1.0m





本公司所有网站, 彩页所涉及到的图片, 文件, 商标, 版权均属于原作者, 本处出于产品说明需要而引用, 绝无它用

公司官方网站 :<http://www.touch-sz.com>



# 直插式脉搏血氧饱和度探头

## Direct Reusable Spo2 Sensor

兼容品牌 Manufacturer	产品编号 P/N	产品描述 Product description	兼容型号 Compatibility	仪器端插头 Interface	产品长度 Length
日本光电 NIHON KOHDEN	SP-193	新生儿包裹式 Neonate silicone Wrap	BSM-4101, 4103, 4111, 4113 LifeSope		1.0m
	SP-194	儿童指夹式 Pediatric finger clip			1.0m
	SP-195	儿童软指套式 Pediatric silicone soft tip			1.0m
	SP-196	成人指夹式 Adult finger clip			1.0m
	SP-197	成人软指套 Adult silicone soft tip			1.0m
	SP-198	成人耳夹式 Adult ear clip probe			1.0m
日本光电 NIHON KOHDEN	SP-199	新生儿包裹式 Neonate silicone Wrap	BSM-4101, 4103, 4111, 4113 LifeSope		3.0m
	SP-200	儿童指夹式 Pediatric finger clip			3.0m
	SP-201	儿童软指套式 Pediatric silicone soft tip			3.0m
	SP-202	成人指夹式 Adult finger clip			3.0m
	SP-203	成人软指套 Adult silicone soft tip			3.0m
	SP-204	成人耳夹式 Adult ear clip probe			3.0m
日本光电 NIHON KOHDEN	SP-205	新生儿包裹式 Neonate silicone Wrap	AL-800PA Module, BSM-1101 LifeScope EC, BSM- 2101/2 LifeScope L, BSM-3101/2 LifeScope L, BSM- LifeScope LC, BSM- 7100/7200/2 LifeScope 8, BMS- 8200/1 LifeScope 12, BSM-8800 LifeScope 14,		3.0m
	SP-206	儿童指夹式 Pediatric finger clip			3.0m
	SP-207	儿童软指套式 Pediatric silicone soft tip			3.0m
	SP-208	成人指夹式 Adult finger clip			3.0m
	SP-209	成人软指套 Adult silicone soft tip			3.0m
	SP-210	成人耳夹式 Adult ear clip probe			3.0m
燕牌 NONIN	SP-211	新生儿包裹式 Neonate silicone Wrap	NONIN:8500, 860, 870 0, 8800		3.0m
	SP-212	儿童指夹式 Pediatric finger clip			3.0m
	SP-213	儿童软指套式 Pediatric silicone soft tip			3.0m
	SP-214	成人指夹式 Adult finger clip			3.0m
	SP-215	成人软指套 Adult silicone soft tip			3.0m
	SP-216	成人耳夹式 Adult ear clip probe			3.0m





本公司所有网站, 彩页所涉及到的图片, 文件, 商标, 版权均属于原作者, 本处出于产品说明需要而引用, 绝无它用

公司官方网站 : <http://www.touch-sz.com>

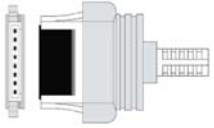

# 直插式脉搏血氧饱和度探头

## Direct Reusable Spo2 Sensor

兼容品牌 Manufacturer	产品编号 P/N	产品描述 Product description	兼容型号 Compatibility	仪器端插头 Interface	产品长度 Length
燕牌 NONIN	SP-217	新生儿包裹式 Neonate silicone Wrap	8600series, 8500, 8700, 8800, 96009, 700		3.0m
	SP-218	儿童指夹式 Pediatric finger clip			3.0m
	SP-219	儿童软指套式 Pediatric silicone soft tip			3.0m
	SP-220	成人指夹式 Adult finger clip			3.0m
	SP-221	成人软指套 Adult silicone soft tip			3.0m
	SP-222	成人耳夹式 Adult ear clip probe			3.0m
诺医 NOVAMETRIX	SP-223	新生儿包裹式 Neonate silicone Wrap	诺医:505, 510, 511, 515B/C, 520, 7000, 7100, 0xypleth;original: 8776-00.		3.0m
	SP-224	儿童指夹式 Pediatric finger clip			3.0m
	SP-225	儿童软指套式 Pediatric silicone soft tip			3.0m
	SP-226	成人指夹式 Adult finger clip			3.0m
	SP-227	成人软指套 Adult silicone soft tip			3.0m
	SP-228	成人耳夹式 Adult ear clip probe			3.0m
诺医 NOVAMETRIX	SP-229	新生儿包裹式 Neonate silicone Wrap	太空:90351-D/G, 90465, 90466, 90467, 90489, 90651-07/08, 90418-01, 90651A-07		3.0m
	SP-230	儿童指夹式 Pediatric finger clip			3.0m
	SP-231	儿童软指套式 Pediatric silicone soft tip			3.0m
	SP-232	成人指夹式 Adult finger clip			3.0m
	SP-233	成人软指套 Adult silicone soft tip			3.0m
	SP-234	成人耳夹式 Adult ear clip probe			3.0m
欧美达 OHMEDA	SP-235	新生儿包裹式 Neonate silicone Wrap	Datex-Ohmeda:3710, 3740, 4700xiCap, 5250RGM, Biox3760, ohmeda 3700, 3770, 3775, Ras cal II		3.0m
	SP-236	儿童指夹式 Pediatric finger clip			3.0m
	SP-237	儿童软指套式 Pediatric silicone soft tip			3.0m
	SP-238	成人指夹式 Adult finger clip			3.0m
	SP-239	成人软指套 Adult silicone soft tip			3.0m
	SP-240	成人耳夹式 Adult ear clip probe			3.0m





本公司所有网站, 彩页所涉及到的图片, 文件, 商标, 版权均属于原作者, 本处出于产品说明需要而引用, 绝无它用

公司官方网站 :<http://www.touch-sz.com>



# 直插式脉搏血氧饱和度探头

## Direct Reusable Spo2 Sensor

兼容品牌 Manufacturer	产品编号 P/N	产品描述 Product description	兼容型号 Compatibility	仪器端插头 Interface	产品长度 Length
欧美达 OHMEDA	SP-241	新生儿包裹式 Neonate silicone Wrap	Datex- Ohmeda:3740, 3710, o nly use for Ohmeda oximeter, EMI TTER:660/940-3		1.0m
	SP-242	儿童指夹式 Pediatric finger clip			1.0m
	SP-243	儿童软指套式 Pediatric silicone soft tip			1.0m
	SP-244	成人指夹式 Adult finger clip			1.0m
	SP-245	成人软指套 Adult silicone soft tip			1.0m
	SP-246	成人耳夹式 Adult ear clip probe			1.0m
伯斯特 Pace Tech Generra	SP-247	新生儿包裹式 Neonate silicone Wrap	Pace Tech:Model1520. Alw /black face(except Vitalmax 800 w/Nellcor spo2) Generra:200, 300, 40 0, 530, 710, 810		3.0m
	SP-248	儿童指夹式 Pediatric finger clip			3.0m
	SP-249	儿童软指套式 Pediatric silicone soft tip			3.0m
	SP-250	成人指夹式 Adult finger clip			3.0m
	SP-251	成人软指套 Adult silicone soft tip			3.0m
	SP-252	成人耳夹式 Adult ear clip probe			3.0m
派克 PALCO	SP-253	新生儿包裹式 Neonate silicone Wrap	PALCO:ALL		3.0m
	SP-254	儿童指夹式 Pediatric finger clip			3.0m
	SP-255	儿童软指套式 Pediatric silicone soft tip			3.0m
	SP-256	成人指夹式 Adult finger clip			3.0m
	SP-257	成人软指套 Adult silicone soft tip			3.0m
	SP-258	成人耳夹式 Adult ear clip probe			3.0m
飞利浦 PJILIPS	SP-259	新生儿包裹式 Neonate silicone Wrap	Philips:M3, M4, MP20 , MP30, MP40, MP50, MP 70, MP80, VM4, VM6, VM 8		1.5m/3.0m
	SP-260	儿童指夹式 Pediatric finger clip			1.5m/3.0m
	SP-261	儿童软指套式 Pediatric silicone soft tip			1.5m/3.0m
	SP-262	成人指夹式 Adult finger clip			1.5m/3.0m
	SP-263	成人软指套 Adult silicone soft tip			1.5m/3.0m
	SP-264	成人耳夹式 Adult ear clip probe			1.5m/3.0m

本公司所有网站, 彩页所涉及到的图片, 文件, 商标, 版权均属于原作者, 本处出于产品说明需要而引用, 绝无它用

公司官方网站 :<http://www.touch-sz.com>



# 直插式脉搏血氧饱和度探头

## Direct Reusable Spo2 Sensor

兼容品牌 Manufacturer	产品编号 P/N	产品描述 Product description	兼容型号 Compatibility	仪器端插头 Interface	产品长度 Length
飞利浦 PHILIPS	SP-265	新生儿包裹式 Neonate silicone Wrap	Philips:78352A/C, 78354A/C, 78834C, M1020A, M1025A/B, M1205A, M1305B, M1722A/B, M1723A/B, M2475B, V24E		3.0m
	SP-266	儿童指夹式 Pediatric finger clip			3.0m
	SP-267	儿童软指套式 Pediatric silicone soft tip			3.0m
	SP-268	成人指夹式 Adult finger clip			3.0m
	SP-269	成人软指套 Adult silicone soft tip			3.0m
	SP-270	成人耳夹式 Adult ear clip probe			3.0m
丹麦阿堤玛 S&W ARTEMA	SP-271	新生儿包裹式 Neonate silicone Wrap	S&W (Diascope G2) Patient monitor Diascope 1, 2, 3		3.0m
	SP-272	儿童指夹式 Pediatric finger clip			3.0m
	SP-273	儿童软指套式 Pediatric silicone soft tip			3.0m
	SP-274	成人指夹式 Adult finger clip			3.0m
	SP-275	成人软指套 Adult silicone soft tip			3.0m
	SP-276	成人耳夹式 Adult ear clip probe			3.0m
席勒 SCHILLER (NELLCOR)	SP-277	新生儿包裹式 Neonate silicone Wrap	Schiller Argus TM-7		3.0m
	SP-278	儿童指夹式 Pediatric finger clip			3.0m
	SP-279	儿童软指套式 Pediatric silicone soft tip			3.0m
	SP-280	成人指夹式 Adult finger clip			3.0m
	SP-281	成人软指套 Adult silicone soft tip			3.0m
	SP-282	成人耳夹式 Adult ear clip probe			3.0m
席勒 SCHILLER (MASIMO)	SP-283	新生儿包裹式 Neonate silicone Wrap	Argus Pro, Argus LCM		3.0m
	SP-284	儿童指夹式 Pediatric finger clip			3.0m
	SP-285	儿童软指套式 Pediatric silicone soft tip			3.0m
	SP-286	成人指夹式 Adult finger clip			3.0m
	SP-287	成人软指套 Adult silicone soft tip			3.0m
	SP-288	成人耳夹式 Adult ear clip probe			3.0m





本公司所有网站, 彩页所涉及到的图片, 文件, 商标, 版权均属于原作者, 本处出于产品说明需要而引用, 绝无它用

公司官方网站 : <http://www.touch-sz.com>



# 直插式脉搏血氧饱和度探头

## Direct Reusable Spo2 Sensor

兼容品牌 Manufacturer	产品编号 P/N	产品描述 Product description	兼容型号 Compatibility	仪器端插头 Interface	产品长度 Length
西门子 SIEMENS	SP-289	新生儿包裹式 Neonate silicone Wrap	Siemens medical:Sirecust 630, Sirecust 700, Sirem SP02 Module		3.0m
	SP-290	儿童指夹式 Pediatric finger clip			3.0m
	SP-291	儿童软指套式 Pediatric silicone soft tip			3.0m
	SP-292	成人指夹式 Adult finger clip			3.0m
	SP-293	成人软指套 Adult silicone soft tip			3.0m
	SP-294	成人耳夹式 Adult ear clip probe			3.0m
太空 SPACELABS	SP-295	新生儿包裹式 Neonate silicone Wrap	Spacelabs:90351- 0/6, 90465, 0466, 904 89, 90651A- 08, 90651- A, IM77, 90303, PC Scout		3.0m
	SP-296	儿童指夹式 Pediatric finger clip			3.0m
	SP-297	儿童软指套式 Pediatric silicone soft tip			3.0m
	SP-298	成人指夹式 Adult finger clip			3.0m
	SP-299	成人软指套 Adult silicone soft tip			3.0m
	SP-300	成人耳夹式 Adult ear clip probe			3.0m
太空 Spacelabs	SP-301	新生儿包裹式 Neonate silicone Wrap	Spacelabs:1050, 160 0, 1700, 90369, 90469 , 90496		3.0m
	SP-302	儿童指夹式 Pediatric finger clip			3.0m
	SP-303	儿童软指套式 Pediatric silicone soft tip			3.0m
	SP-304	成人指夹式 Adult finger clip			3.0m
	SP-305	成人软指套 Adult silicone soft tip			3.0m
	SP-306	成人耳夹式 Adult ear clip probe			3.0m
太空 Spacelabs	SP-307	新生儿包裹式 Neonate silicone Wrap	GMI:G3C Newtech:G3C		3.0m
	SP-308	儿童指夹式 Pediatric finger clip			3.0m
	SP-309	儿童软指套式 Pediatric silicone soft tip			3.0m
	SP-310	成人指夹式 Adult finger clip			3.0m
	SP-311	成人软指套 Adult silicone soft tip			3.0m
	SP-312	成人耳夹式 Adult ear clip probe			3.0m

本公司所有网站, 彩页所涉及到的图片, 文件, 商标, 版权均属于原作者, 本处出于产品说明需要而引用, 绝无它用

公司官方网站 : <http://www.touch-sz.com>





# 血氧转接线

## Spo2 Sensor Extension Cable



探头端：

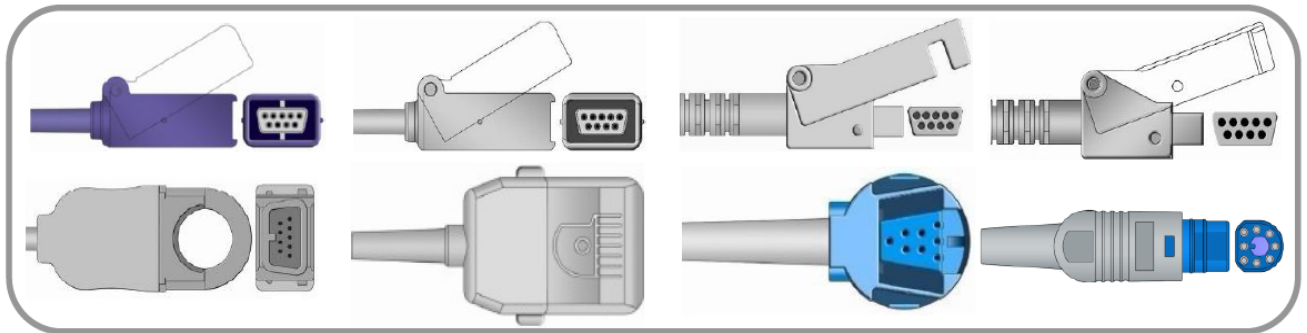



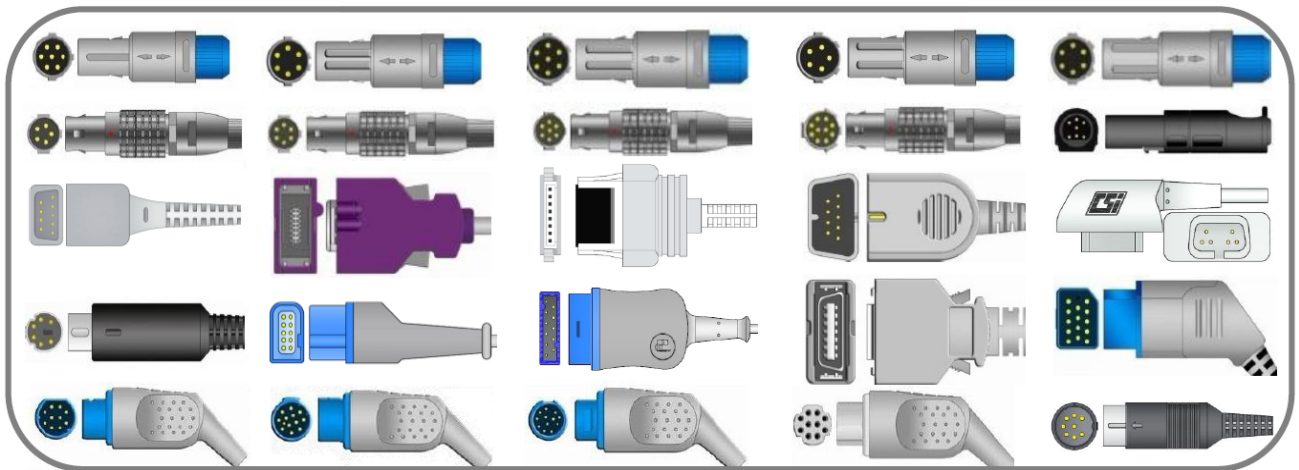







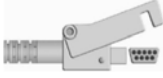

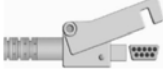

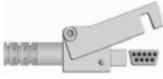

设备端连接器：



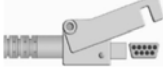

# 血氧转接线

## Spo2 Sensor Extension cable

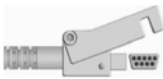
兼容品牌 Manufacturer	产品编号 P/N	产品描述 Product description	兼容型号 Compatibility Model	仪器端插头 Interface	
BCI	SS-001	DB-9M & DB-9F, L=8ft, 与BCI短线探头匹配	(BCI) 3300, 3301, 3302, 3303, 3304, 3401		
BCI	SS-002	单定位7针插头 & DB-9F, L=8ft, 与BCI短线探头匹配	(BCI) 6100, 9100, Advisor, Autocorr, Mini Torr BCI		
Bionet	SS-003	单定位7针插头 & DB-9F, L=8ft, 与Bionet短线探头匹配	BM3Vet, BM31		
Biosys	SS-004	MINI DIN-9M & DB-9F, L=8ft, 与Nellcor短线探头匹配	BPM300		
布鲁克 Bruker	SS-005	圆形12针插头 & DB-9F, L=8ft, 与BCI短线探头匹配	DC-3002, IH, M3		
科瑞康 Creative	SS-006	单定位7针插头 & DB-9F, L=8ft, 与BCI短线探头匹配	PC9000, UP6000		
CSI	SS-007	MD-9M & DB-9F, L=8ft, 与CSI短线探头匹配	503 Spot, 506 Spot, 507SD		
CSI	SS-008	金属7针插头 & DB-9F, L=8ft, 与CSI短线探头匹配	Scholar, Poet (6023A) 1100, 501 503, 504, 507, 507SD, 508, 581		
Datascope	SS-009	DIN-8P & DB-9F, L=8ft, 与Datascope短线探头匹配	Accusat, Accutorr 3/4 SAT, Accutorr Plus		
德恩 Datex	SS-010	圆形10孔插头 & DB-9F, L=2.4m, 与德恩短线探头匹配	AS/3, CS/3, CH/S, CH/2S, CH-RS, CG/2S, Cardiocap I,		











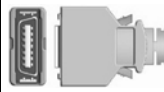
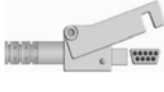

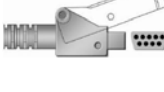

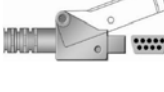

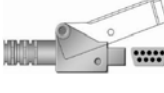

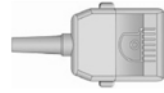
本公司所有网站, 彩页所涉及到的图片, 文件, 商标, 版权均属于原作者, 本处出于产品说明需要而引用, 绝无它用

公司官方网站 : <http://www.touch-sz.com>

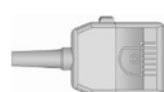

# 血氧转接线

## Spo2 Sensor Extension cable

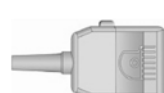
兼容品牌 Manufacturer	产品编号 P/N	产品描述 Product description	兼容型号 Compatibility Model	仪器端插头 Interface	
海豚 Dolphin Medical (OSI)	SS-011	AMP-14P & DB-9F, L=8ft, 与海豚短线探头匹配	Dolphin ONE Oximeters		
西门子 德尔格 Simens Drage	SS-012	圆形7P & DB-9F, L=8ft, 与奈普特NELLCOR短线探头匹配	SC 6002XL, SC7000, SC8000, SC9000XL		
海立格 GE-Hellige	SS-013	圆形7P & DB-9F, L=8ft, 与奈普特NELLCOR短线探头匹配	SC 6002XL, SC7000, SC8000, SC9000XL		
通用-马葵 GE-Medical (NELLCOR)	SS-014	方形11针 & DB-9F, L=2.4m, 与奈普特NELLCOR短线探头匹配	Eagle GE, Dash GE, Solar GE, TRAM Modularx50SL Series (nellcor mould)		
通用-马葵 GE-Medical (MASIMO)	SS-015	方形11针 & DB-9F, L=2.4m, 与奈普特MASIMOLNOP血氧探头	Eagle GE, Dash GE, Solar GE, TRAM (masimo mould)		
通用-马葵 GE-Medical (OXI-TECH)	SS-016	方形11针 & DB-9F, L=2.4m, 可兼容原装DS-100A血氧探头	Dash 2500 (Oximax mould)		
通用-马葵 GE-Medical (OHMEDA)	SS-017	方形11针 & 抓型8孔母插, L=2.4m, 可兼容欧美达血氧探头	Sensor solutions for Datex-ohmeda S/5 FM Ports		
INVIVO	SS-018	7针圆形金属插头 & DB-9F, L=8ft, 可兼容耐普特(NELLCOR)血氧探头	4500, 4500plus, Millenia, Omega1445, Omni-TrakTVS Sat Scout, original cable number 9383		
马斯默 MASIMO	SS-019	AMP -14P & 马斯默-6F, L=8ft, 可兼容马斯默LNOP血氧探头	GE:PRO1000, V300 INVIO:T8 Schiller ZOLL, Masimo Datascop: Trio, Passport 2, Spectrum		
美克 MEK	SS-020	DB-9M & DB-9F, L=2.4m, 可兼容美克血氧探头	New Modle Mahine of MEK 8PIN JACK		

本公司所有网站, 彩页所涉及到的图片, 文件, 商标, 版权均属于原作者, 本处出于产品说明需要而引用, 绝无它用

公司官方网站 : <http://www.touch-sz.com>



# 血氧转接线

## Spo2 Sensor Extension cable

兼容品牌 Manufacturer	产品编号 P/N	产品描述 Product description	兼容型号 Compatibility Model	仪器端插头 Interface	
美能 MENNEN	SS-021	10针插头 & DB-9F, L=8ft, 可兼容耐普特血氧探头	Horizon2000		
美能 MENNEN	SS-022	10针插头 & DB-9F, L=8ft, 可兼容耐普特血氧探头			
康强 Kontron	SS-023	10针插头 & DB-9F, L=8ft, 可兼容耐普特血氧探头	Kontron 7840, 7845, Minimom7137, Kolormon, Micromon, Supermon, Trakmon		
迈瑞 MINDRAY	SS-024	5针单槽塑料插头 & DB-9F, L=2.4m, 可兼容马斯默血氧探头	Mindray PM9000; Goldway: ut4000A; Jerry: PM2000; Hongrunda: EM-6		
迈瑞 MINDRAY	SS-025	6针双槽40度塑料插头 & DB-9F, L=2.4m, 可兼容耐普特血氧探头	Mindray PM7000, PM8000, PM9000, 1000 (Nellcor & Mindray模块)		
迈瑞 MINDRAY	SS-026	6针双槽40度塑料插头 & DB-9F, L=2.4m, 可兼容马斯默血氧探头	PM7000, PM8000, PM9000, 1000 (Masimo模块)		
迈瑞 MINDRAY	SS-027	6针双槽40度塑料插头 & DB-9F, L=2.4m, 可兼容耐普特血氧探头	PM7000, PM8000, PM9000, 1000 (Nellcor & Mindray模块)		
迈瑞 MINDRAY	SS-028	6针双槽40度塑料插头 & DB-9F, L=2.4m, 可兼容马斯默血氧探头	PM7000, PM8000, PM9000, 1000 (Masimo模块)		
迈瑞 MINDRAY	SS-029	5针雷莫1B金属插头 & DB-9F, L=2.4m, 可兼容CSI血氧探头	MEC509, MEC509+, MEC503, MEC507		
迈瑞 MINDRAY	SS-030	6针双槽80度塑料插头 & DB-9F, L=2.4m, 可兼容耐普特血氧探头	MEC509, MEC509+, MEC503, MEC507		











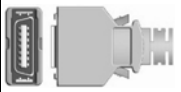
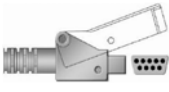

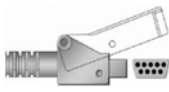



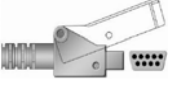

本公司所有网站, 彩页所涉及到的图片, 文件, 商标, 版权均属于原作者, 本处出于产品说明需要而引用, 绝无它用

公司官方网站 : <http://www.touch-sz.com>

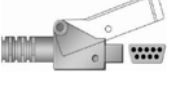

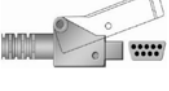
# 血氧转接线

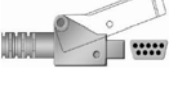
## Spo2 Sensor Extension cable

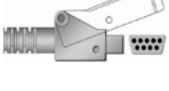
兼容品牌 Manufacturer	产品编号 P/N	产品描述 Product description	兼容型号 Compatibility Model	仪器端插头 Interface	
奈普特 NELLCOR	SS-031	AMP-14P & DB-9F, L=2.4m, 可兼容耐普特血氧探头	Nellcor, without oximax		
奈普特 NELLCOR	SS-032	DB-9M & DB-9F, L=2.4m, 可兼容奈普特血氧探头	Datascope:Expert, Passport GE:Corometrics 188 Corometrics 129 Critikon Dinamap 9700Critikon Dinamap 9710Critikon		
奈普特 NELLCOR	SS-033	AMP-14P & DB-9F, L=2.4m, 可兼容耐普特OXI技术的血氧探头	GE Dinamap PRO(w/Oxi), Datascope:Accu- rr Plus (Nellcor Spo2) Nellcor:NPB-290/5(w/Oxi), N- 390(w/Oxi), N-395(w/Oxi), N- 3000(w/Oxi), N- 6000(w/Oxi), NPB- 290/5(w/Oxi),		
奈普特 NELLCOR	SS-034	DB-9M & DB-9F, L=2.4m, 可兼容奈普特OXI血氧探头			
日本光电 Nihon Konden	SS-035	方形14针插头 & DB-9F, L=2.4m, 可兼容日本光电血氧探头	BSM-4101, 4103, 4111, 4113, 5105, 5135, 2351, 2353, 2301, 2303		
日本光电 Nihon Konden	SS-036	圆形10针插头 & DB-9F, L=2.4m, 可兼容日本光电血氧探头	AL-800PA, BSM- 1101, 2101, 2102, 3101, 7100, 72 00, 8200, 8201, 8301, 8302, SM- 8800, OLV-1100A		
燕牌 Nonin	SS-037	FGG. 1b. 6针插头 & DB-9F, L=8ft, 可兼容Nonin短线血氧探头	8604, 8604D		
燕牌 Nonin	SS-038	杜邦8针插头 & DB-9F, L=8ft, 可兼容燕牌血氧探头	8600 series, 8500, 8700, 8800, 9600, 9700		
诺医 Novamatrix	SS-039	塑Hys-7p & DB-9F, L=8ft, 适宜连接Novamatrix短线探头	Nuoyi:505, 510, 511, 515B/C, 52 0, 7000, 7100, Oxypleth Spacelabs:90351- D/G, 90465, 90466, 90467, 90489 , 90651-07/08, 90419-		
欧美达 Ohmeda	SS-040	塑Hys-7p & DB-9F, L=8ft, 适宜连接欧美达短线探头	3700, 3710, 3770, 3775, Biox374 0, 3760, 3800, OxiCap, 4700 Oxicap, 5250RGM		

本公司所有网站, 彩页所涉及到的图片, 文件, 商标, 版权均属于原作者, 本处出于产品说明需要而引用, 绝无它用

公司官方网站 : <http://www.touch-sz.com>



# 血氧转接线

## Spo2 Sensor Extension cable

兼容品牌 Manufacturer	产品编号 P/N	产品描述 Product description	兼容型号 Compatibility Model	仪器端插头 Interface	
欧美达 Ohmeda	SS-041	塑Hys-7p & DB-9F, L=8ft, 适宜连接欧美达短线探头	3700, 3710, 3770, 3775, Biox3740, 3760, 3800, OxiCap, 4700 Oxicap, 5250RGM		
伯斯特 PACE TECH 将军 GENERAL	SS-042	7针塑料插头 & DB-9F, L=8ft, 适宜连接BCI短线探头	Pace Tech:ALL w/black face (except Vitalmax 800 w/Nellcor SPO2) Generra:200, 300, 400, 530, 710, 810		
伯斯特 PACE TECH 将军 GENERAL	SS-043	迷你卡龙5J & DB-9F, L=8ft, 适宜连接BCI短线探头	Generra		
飞利浦 PHILIPS	SS-044	马蹄形8P插头 & 马蹄形8P母头, L=2.4m, 适宜连接飞利浦血氧探头	M2601A, M3000A, M3500B, M4735A		
飞利浦 PHILIPS	SS-045	马蹄形8P插头 & DB-9F, L=2.4m, 适宜连接飞利浦血氧探头	M2601A, M3000A, M3500B, M4735A		
飞利浦 PHILIPS	SS-046	圆形12针插头 & 马蹄形8P母头, L=2.4m, 适宜连接飞利浦血氧探头	M2475B, M1732A/B, M1722A/B, M1020A, 78833A, 78833C, 78834A, 78352A, 78352C		
飞利浦 PHILIPS	SS-047	圆形12针插头 & DB-9F, L=2.4m, 适宜连接飞利浦血氧探头	M2475B, M1732A/B, M1722A/B, M1020A, 78833A, 78833C, 78834A, 78352A, 78352C		
丹麦阿堤玛 S&W ARTEMA	SS-048	半圆形10针插头 & DB-9F, L=2.4m, 适宜连接NELLCOR血氧探头	S&W (Diascope G2) Patient monitor, Diascope1, 2, 3		
席勒 SCHILLER	SS-049	DIN式7针插头 & DB-9F, L=2.4m, 适宜连接奈普特血氧探头	Schiller Argus TM-7		
席勒 SCHILLER	SS-050	DIN式7针插头 & 马斯默6P, L=2.4m, 适宜连接马斯默血氧探头	Argus Pro, Argus LCM		





本公司所有网站, 彩页所涉及到的图片, 文件, 商标, 版权均属于原作者, 本处出于产品说明需要而引用, 绝无它用

公司官方网站 : <http://www.touch-sz.com>

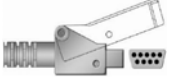

# 血氧转接线

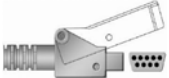
## Spo2 Sensor Extension cable

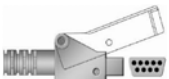
兼容品牌 Manufacturer	产品编号 P/N	产品描述 Product description	兼容型号 Compatibility Model	仪器端插头 Interface	
西门子 SIEMENS	SS-051	圆形10P插头 & DB-9F, L=8ft, 适宜连接 NELLOCOR血氧探头	Siemens medical:Sirecust 630, Sirecust 700, Sirem SP02 Module		
太空	SS-052	伊倍达12针插头 & DB-9F, L=2.4m, 适宜连接奈普特血氧探头	Spacelabs:90351-0/6, 90465, 0466, 90489, 90651a-08, 90651-a, im77, 90303, PC Scout		
	SS-053	方形10针插头 & DB-9F, L=2.4m, 适宜连接奈普特血氧探头	Spacelabs-1050, 1600, 1700, 90369, 90469, 90496		



# 一次性脉搏血氧饱和度探头 Disposable Spo2 Sensor cable

监护仪

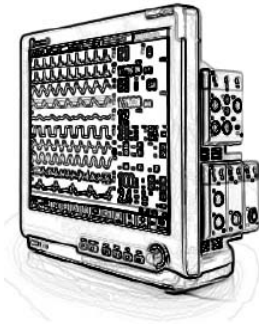

探头端:



新生儿, 成人一次性脉搏血氧饱和度探头,  
适用于: <3kg的新生儿和>30kg的成人  
适用位置: 新生儿脚掌, 成人食指或其他手指



儿童一次性脉搏血氧饱和度探头,  
适用于: 10-50kg的儿童  
适用位置: 食指或其他手指



婴儿一次性脉搏血氧饱和度探头,  
适用于: 3-20kg的婴儿  
适用位置: 脚趾头



新生儿, 成人一次性脉搏血氧饱和度探头,  
适用于: <3kg的新生儿和>30kg的成人  
适用位置: 新生儿脚掌, 成人食指或其他手指

设备端连接器:

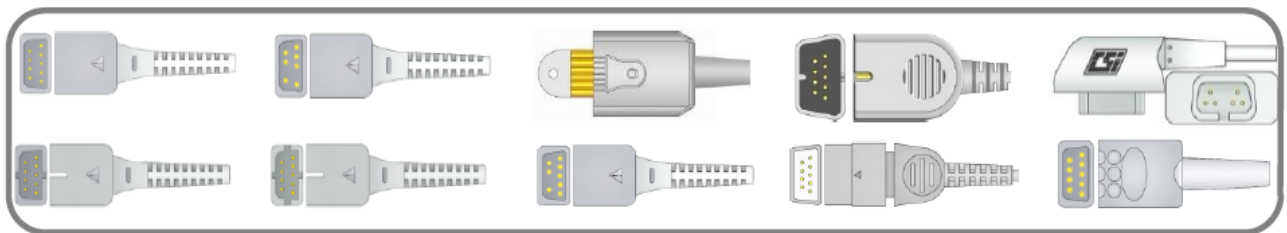









# 一次性脉搏血氧饱和度探头

## Disposable Spo2 Sensor cable

兼容品牌 Manufacturer	产品编号 P/N	产品描述 Product description	兼容型号 Compatibility Model	仪器端插头 Interface
BCI (BIOCHEM INTERNATIONAL)	DS-001	成人一次性血氧饱和度探头, L=45cm Adult Disposable Spo2 Sensor	BCI (Biochem International): 3401, 3304, 3303, 3302, 3301, 3300;	
	DS-002	儿童一次性血氧饱和度探头, L=45cm Pediatric Disposable Spo2 Sensor		
	DS-003	婴儿一次性血氧饱和度探头, L=90cm Infant Disposable Spo2 Sensor		
	DS-004	新生儿一次性血氧饱和度探头, L=90cm Neonate Disposable Spo2 Sensor		
CSI (Criticare Systems International)	DS-005	成人一次性血氧饱和度探头, L=45cm Adult Disposable Spo2 Sensor	Alaris (IVAC): VitalCheck 4400, CSI: 503DX, 503Spot, 504DX, 506, 506DX, 507ELC2 ScholarII, 8100Poet Plus, Poet (602-3A), Scholar	
	DS-006	儿童一次性血氧饱和度探头, L=45cm Pediatric Disposable Spo2 Sensor		
	DS-007	婴儿一次性血氧饱和度探头, L=90cm Infant Disposable Spo2 Sensor		
	DS-008	新生儿一次性血氧饱和度探头, L=90cm Neonate Disposable Spo2 Sensor		
DATASCOPE	DS-009	成人一次性血氧饱和度探头, L=45cm Adult Disposable Spo2 Sensor	Datascope: Accutorr 3/4 SAT, Accutorr Plus, Passport (Database Spo2), Compatible for 0020-00-071-01	
	DS-010	儿童一次性血氧饱和度探头, L=45cm Pediatric Disposable Spo2 Sensor		
	DS-011	婴儿一次性血氧饱和度探头, L=90cm Infant Disposable Spo2 Sensor		
	DS-012	新生儿一次性血氧饱和度探头, L=90cm Neonate Disposable Spo2 Sensor		
德恩 DATEX	DS-013	成人一次性血氧饱和度探头, L=45cm Adult Disposable Spo2 Sensor	AS/3, CH/S, CH/2S, CH-RS, CG/2S, CardiocapII, Cardiocap 5, Capnomac Uitima, Light Monitor, M-Estrp, OSP-200, Satlite Trans, Trans Plus, System5, ULSIO, ULTSVI, ULTSV0, original factory code: DAF-F4	
	DS-014	儿童一次性血氧饱和度探头, L=45cm Pediatric Disposable Spo2 Sensor		
	DS-015	婴儿一次性血氧饱和度探头, L=90cm Infant Disposable Spo2 Sensor		
	DS-016	新生儿一次性血氧饱和度探头, L=90cm Neonate Disposable Spo2 Sensor		
海豚 DOLPHIN (OSI)	DS-017	成人一次性血氧饱和度探头, L=45cm Adult Disposable Spo2 Sensor	Dolphin ONE Oximeters, *digital PD output directly DS, Copatible original: 360	
	DS-018	儿童一次性血氧饱和度探头, L=45cm Pediatric Disposable Spo2 Sensor		
	DS-019	婴儿一次性血氧饱和度探头, L=90cm Infant Disposable Spo2 Sensor		
	DS-020	新生儿一次性血氧饱和度探头, L=90cm Neonate Disposable Spo2 Sensor		





本公司所有网站, 彩页所涉及到的图片, 文件, 商标, 版权均属于原作者, 本处出于产品说明需要而引用, 绝无它用

公司官方网站 : <http://www.touch-sz.com>



# 一次性脉搏血氧饱和度探头

## Disposable Spo2 Sensor cable

兼容品牌 Manufacturer	产品编号 P/N	产品描述 Product description	兼容型号 Compatibility Model	仪器端插头 Interface
马斯默 MASIMO	DS-021	成人一次性血氧饱和度探头, L=45cm Adult Disposable Spo2 Sensor	Redical	
	DS-022	儿童一次性血氧饱和度探头, L=45cm Pediatric Disposable Spo2 Sensor		
	DS-023	婴儿一次性血氧饱和度探头, L=90cm Infant Disposable Spo2 Sensor		
	DS-024	新生儿一次性血氧饱和度探头, L=90cm Neonate Disposable Spo2 Sensor		
奈普特 NELLCOR	DS-025	成人一次性血氧饱和度探头, L=45cm Adult Disposable Spo2 Sensor	Nellcor: N100 (req. preamp cable), N180, N200 (reg. preamp cable), N-20, NPB-40, NPB-75, NPB-290/5, N-390, N-395, N-3000, N-6000	
	DS-026	儿童一次性血氧饱和度探头, L=45cm Pediatric Disposable Spo2 Sensor		
	DS-027	婴儿一次性血氧饱和度探头, L=90cm Infant Disposable Spo2 Sensor		
	DS-028	新生儿一次性血氧饱和度探头, L=90cm Neonate Disposable Spo2 Sensor		
奈普特 NELLCOR	DS-029	成人一次性血氧饱和度探头, L=45cm Adult Disposable Spo2 Sensor	Nellcor: N100 (req. preamp cable), N180, N200 (reg. preamp cable), N-20, NPB-40, NPB-75, NPB-290/5, N-390, N-395, N-3000, N-6000	
	DS-030	儿童一次性血氧饱和度探头, L=45cm Pediatric Disposable Spo2 Sensor		
	DS-031	婴儿一次性血氧饱和度探头, L=90cm Infant Disposable Spo2 Sensor		
	DS-032	新生儿一次性血氧饱和度探头, L=90cm Neonate Disposable Spo2 Sensor		
日本光电 NIHON KOHDEN	DS-033	成人一次性血氧饱和度探头, L=45cm Adult Disposable Spo2 Sensor	Bedside Monitor: BSM-4101, 4103, 4111, 4113 Life scope P, BMS 5105, 5135 Life scope A, BSM-2351, 2353 Life scope L, BSM-2301, 2303 Life scope I	
	DS-034	儿童一次性血氧饱和度探头, L=45cm Pediatric Disposable Spo2 Sensor		
	DS-035	婴儿一次性血氧饱和度探头, L=90cm Infant Disposable Spo2 Sensor		
	DS-036	新生儿一次性血氧饱和度探头, L=90cm Neonate Disposable Spo2 Sensor		
日本光电 NIHON KOHDEN	DS-037	成人一次性血氧饱和度探头, L=45cm Adult Disposable Spo2 Sensor	AL-800PA Module, BSM-1101 LifeScope EC, BSM-2101/2 LifeScope L, BSM-3101 LifeScope LC, BSM-7100/7200 LifeScope8, BSM-8200/1 LifeScope 12, BSM-8301/2 LifeScope 9, SM-8800 LifeScope14, OLV-1100A	
	DS-038	儿童一次性血氧饱和度探头, L=45cm Pediatric Disposable Spo2 Sensor		
	DS-039	婴儿一次性血氧饱和度探头, L=90cm Infant Disposable Spo2 Sensor		
	DS-040	新生儿一次性血氧饱和度探头, L=90cm Neonate Disposable Spo2 Sensor		

本公司所有网站, 彩页所涉及到的图片, 文件, 商标, 版权均属于原作者, 本处出于产品说明需要而引用, 绝无它用

公司官方网站 : <http://www.touch-sz.com>



# 一次性脉搏血氧饱和度探头

## Disposable Spo2 Sensor cable

兼容品牌 Manufacturer	产品编号 P/N	产品描述 Product description	兼容型号 Compatibility Model	仪器端插头 Interface
燕牌 NONIN	DS-041	成人一次性血氧饱和度探头, L=45cm Adult Disposable Spo2 Sensor	NONIN:8500, 8600, 8700, 8800	
	DS-042	儿童一次性血氧饱和度探头, L=45cm Pediatric Disposable Spo2 Sensor		
	DS-043	婴儿一次性血氧饱和度探头, L=90cm Infant Disposable Spo2 Sensor		
	DS-044	新生儿一次性血氧饱和度探头, L=90cm Neonate Disposable Spo2 Sensor		
诺医 NOVANMETRIX	DS-045	成人一次性血氧饱和度探头, L=45cm Adult Disposable Spo2 Sensor	Novamatrix:505, 510, 511, 51 5B/C, 520, 7000, 7100, Oxyple th;original match:8776- 00;Spacelabs:90351D/G, 904 65, 90466, 90467, 90489, 9065 1-07/08, 90419-01, 90651A- 07, original match:8776-00	
	DS-046	儿童一次性血氧饱和度探头, L=45cm Pediatric Disposable Spo2 Sensor		
	DS-047	婴儿一次性血氧饱和度探头, L=90cm Infant Disposable Spo2 Sensor		
	DS-048	新生儿一次性血氧饱和度探头, L=90cm Neonate Disposable Spo2 Sensor		
欧美达 OHMEDA	DS-049	成人一次性血氧饱和度探头, L=45cm Adult Disposable Spo2 Sensor	Datex- Ohmeda:3740, 3710, 4700, Oxi Cap, 5250RGM, Biox3760, Ohme da3700, 3770, 3775, RascalII	
	DS-050	儿童一次性血氧饱和度探头, L=45cm Pediatric Disposable Spo2 Sensor		
	DS-051	婴儿一次性血氧饱和度探头, L=90cm Infant Disposable Spo2 Sensor		
	DS-052	新生儿一次性血氧饱和度探头, L=90cm Neonate Disposable Spo2 Sensor		



# 一体式监护心电电缆和导联线

## One-Piece Series Patient Cable With Leads

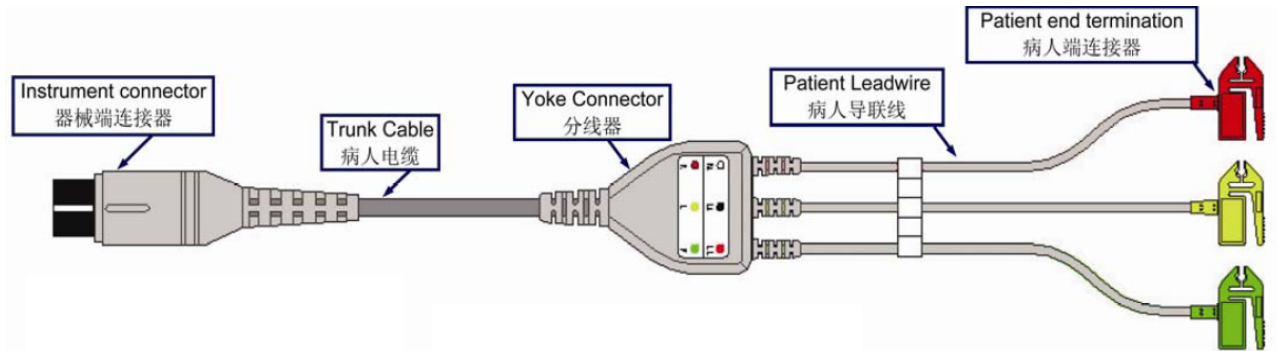

### 导联位置颜色标识:

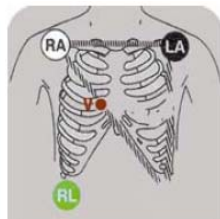

3 导: H  
美国标准(AAMI)

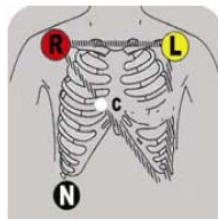

3 导: IH  
欧洲标准(IEC)

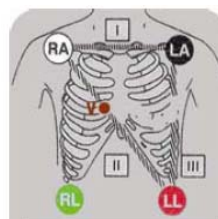

5 导: A  
美国标准(AAMI)

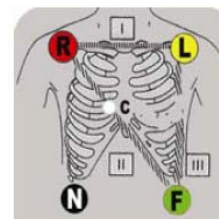

5 导: I  
欧洲标准(IEC)

### 设备端连接器:

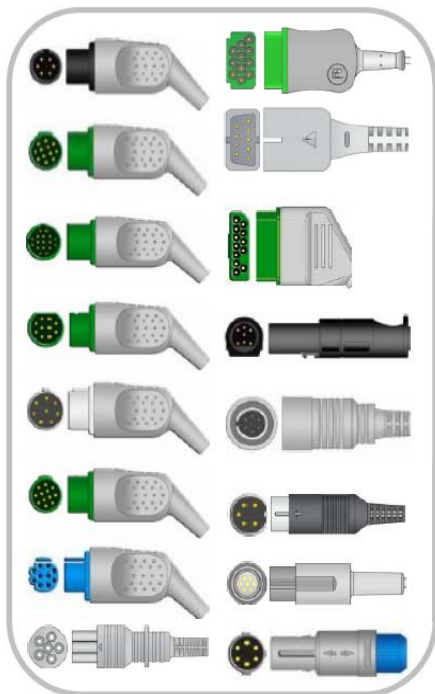

### 病人端:

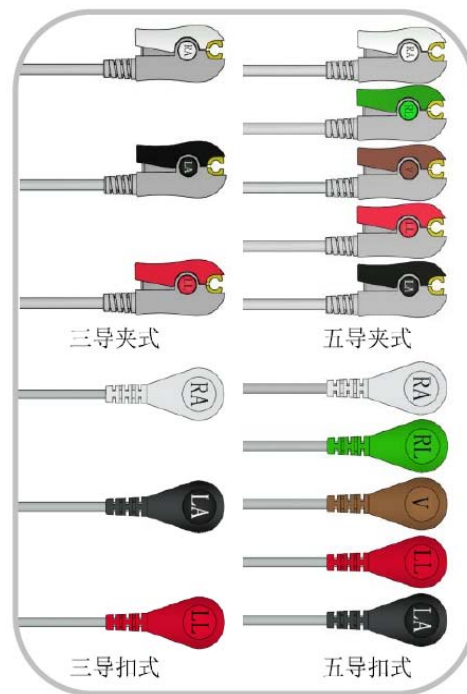



# 一体式监护心电电缆和导联线

## One-Piece Series Patient Cable With Leads

兼容品牌 Manufacturer	产品编号 P/N	产品描述 Product description	兼容型号 Compatibility Model	仪器端插头 Interface
BIONET	EC-001	一体式心电导联线, 三导, 扣式, 美标 ECG CABLE, 3LD, SNAP, AHA	BM3	
	EC-002	一体式心电导联线, 三导, 夹式, 美标 ECG CABLE, 3LD, CLIP, AHA		
	EC-003	一体式心电导联线, 三导, 扣式, 欧标 ECG CABLE, 3LD, SNAP, IEC		
	EC-004	一体式心电导联线, 三导, 夹式, 欧标 ECG CABLE, 3LD, CLIP, IEC		
	EC-005	一体式心电导联线, 五导, 扣式, 美标 ECG CABLE, 5LD, SNAP, AHA		
	EC-006	一体式心电导联线, 五导, 夹式, 美标 ECG CABLE, 5LD, CLIP, AHA		
	EC-007	一体式心电导联线, 五导, 扣式, 欧标 ECG CABLE, 5LD, SNAP, IEC		
	EC-008	一体式心电导联线, 五导, 夹式, 欧标 ECG CABLE, 5LD, CLIP, IEC		
韩国品牌 BIOSYS	EC-009	一体式心电导联线, 三导, 扣式, 美标 ECG CABLE, 3LD, SNAP, AHA	BPM-103	
	EC-010	一体式心电导联线, 三导, 夹式, 美标 ECG CABLE, 3LD, CLIP, AHA		
	EC-011	一体式心电导联线, 三导, 扣式, 欧标 ECG CABLE, 3LD, SNAP, IEC		
	EC-012	一体式心电导联线, 三导, 夹式, 欧标 ECG CABLE, 3LD, CLIP, IEC		
	EC-013	一体式心电导联线, 五导, 扣式, 美标 ECG CABLE, 5LD, SNAP, AHA		
	EC-014	一体式心电导联线, 五导, 夹式, 美标 ECG CABLE, 5LD, CLIP, AHA		
	EC-015	一体式心电导联线, 五导, 扣式, 欧标 ECG CABLE, 5LD, SNAP, IEC		
	EC-016	一体式心电导联线, 五导, 夹式, 欧标 ECG CABLE, 5LD, CLIP, IEC		
布鲁克 BRUKER	EC-017	一体式心电导联线, 三导, 扣式, 美标 ECG CABLE, 3LD, SNAP, AHA	SM784, SM785 With 12-pin input connector	
	EC-018	一体式心电导联线, 三导, 夹式, 美标 ECG CABLE, 3LD, CLIP, AHA		
	EC-019	一体式心电导联线, 三导, 扣式, 欧标 ECG CABLE, 3LD, SNAP, IEC		
	EC-020	一体式心电导联线, 三导, 夹式, 欧标 ECG CABLE, 3LD, CLIP, IEC		



本公司所有网站, 彩页所涉及到的图片, 文件, 商标, 版权均属于原作者, 本处出于产品说明需要而引用, 绝无它用

公司官方网站 : <http://www.touch-sz.com>



# 一体式监护心电电缆和导联线

## One-Piece Series Patient Cable With Leads

兼容品牌 Manufacturer	产品编号 P/N	产品描述 Product description	兼容型号 Compatibility Model	仪器端插头 Interface
布鲁克 BRUKER	EC-021	一体式心电导联线, 五导, 扣式, 美标 ECG CABLE, 5LD, SNAP, AHA	SM784, SM785 With 12-pin input connector	
	EC-022	一体式心电导联线, 五导, 夹式, 美标 ECG CABLE, 5LD, CLIP, AHA		
	EC-023	一体式心电导联线, 五导, 扣式, 欧标 ECG CABLE, 5LD, SNAP, IEC		
	EC-024	一体式心电导联线, 五导, 夹式, 欧标 ECG CABLE, 5LD, CLIP, IEC		
科林 COLIN	EC-025	一体式心电导联线, 三导, 扣式, 美标 ECG CABLE, 3LD, SNAP, AHA	BP88/BP306	
	EC-026	一体式心电导联线, 三导, 夹式, 美标 ECG CABLE, 3LD, CLIP, AHA		
	EC-027	一体式心电导联线, 三导, 扣式, 欧标 ECG CABLE, 3LD, SNAP, IEC		
	EC-028	一体式心电导联线, 三导, 夹式, 欧标 ECG CABLE, 3LD, CLIP, IEC		
	EC-029	一体式心电导联线, 五导, 扣式, 美标 ECG CABLE, 5LD, SNAP, AHA		
	EC-030	一体式心电导联线, 五导, 夹式, 美标 ECG CABLE, 5LD, CLIP, AHA		
	EC-031	一体式心电导联线, 五导, 扣式, 欧标 ECG CABLE, 5LD, SNAP, IEC		
	EC-032	一体式心电导联线, 五导, 夹式, 欧标 ECG CABLE, 5LD, CLIP, IEC		
科林 COLIN	EC-033	一体式心电导联线, 三导, 扣式, 美标 ECG CABLE, 3LD, SNAP, AHA	BP88S	
	EC-034	一体式心电导联线, 三导, 夹式, 美标 ECG CABLE, 3LD, CLIP, AHA		
	EC-035	一体式心电导联线, 三导, 扣式, 欧标 ECG CABLE, 3LD, SNAP, IEC		
	EC-036	一体式心电导联线, 三导, 夹式, 欧标 ECG CABLE, 3LD, CLIP, IEC		
	EC-037	一体式心电导联线, 五导, 扣式, 美标 ECG CABLE, 5LD, SNAP, AHA		
	EC-038	一体式心电导联线, 五导, 夹式, 美标 ECG CABLE, 5LD, CLIP, AHA		
	EC-039	一体式心电导联线, 五导, 扣式, 欧标 ECG CABLE, 5LD, SNAP, IEC		
	EC-040	一体式心电导联线, 五导, 夹式, 欧标 ECG CABLE, 5LD, CLIP, IEC		



本公司所有网站, 彩页所涉及到的图片, 文件, 商标, 版权均属于原作者, 本处出于产品说明需要而引用, 绝无它用

公司官方网站 : <http://www.touch-sz.com>



# 一体式监护心电电缆和导联线

## One-Piece Series Patient Cable With Leads

兼容品牌 Manufacturer	产品编号 P/N	产品描述 Product description	兼容型号 Compatibility Model	仪器端插头 Interface
德恩 DATEX	EC-041	一体式心电导联线, 三导, 扣式, 美标 ECG CABLE, 3LD, SNAP, AHA	AS/3, CS/3, S5, Cardiocap 1, Cardiocap2, Cardiocap 5, Light Monitor, Satliteplus	
	EC-042	一体式心电导联线, 三导, 夹式, 美标 ECG CABLE, 3LD, CLIP, AHA		
	EC-043	一体式心电导联线, 三导, 扣式, 欧标 ECG CABLE, 3LD, SNAP, IEC		
	EC-044	一体式心电导联线, 三导, 夹式, 欧标 ECG CABLE, 3LD, CLIP, IEC		
	EC-045	一体式心电导联线, 五导, 扣式, 美标 ECG CABLE, 5LD, SNAP, AHA		
	EC-046	一体式心电导联线, 五导, 夹式, 美标 ECG CABLE, 5LD, CLIP, AHA		
	EC-047	一体式心电导联线, 五导, 扣式, 欧标 ECG CABLE, 5LD, SNAP, IEC		
	EC-048	一体式心电导联线, 五导, 夹式, 欧标 ECG CABLE, 5LD, CLIP, IEC		
福田 FUKUDA	EC-049	一体式心电导联线, 三导, 扣式, 美标 ECG CABLE, 3LD, SNAP, AHA	DATASCOPE:Expert FUKUDA DENSHI:DS5100E, DS5300W, DS5400, DS7101/L, DS714 1	
	EC-050	一体式心电导联线, 三导, 夹式, 美标 ECG CABLE, 3LD, CLIP, AHA		
	EC-051	一体式心电导联线, 三导, 扣式, 欧标 ECG CABLE, 3LD, SNAP, IEC		
	EC-052	一体式心电导联线, 三导, 夹式, 欧标 ECG CABLE, 3LD, CLIP, IEC		
	EC-053	一体式心电导联线, 五导, 扣式, 美标 ECG CABLE, 5LD, SNAP, AHA		
	EC-054	一体式心电导联线, 五导, 夹式, 美标 ECG CABLE, 5LD, CLIP, AHA		
	EC-055	一体式心电导联线, 五导, 扣式, 欧标 ECG CABLE, 5LD, SNAP, IEC		
	EC-056	一体式心电导联线, 五导, 夹式, 欧标 ECG CABLE, 5LD, CLIP, IEC		
马葵 GE-MEDIQUTTE	EC-057	一体式心电导联线, 三导, 扣式, 美标 ECG CABLE, 3LD, SNAP, AHA	GEMS:Dash PRO4000, Dash PRO3000, Dash PRO2000, Dash PRO1000, Eagle Systems, MAC- Lab, Solar9500, Solar800 0, Solar3000, Tram100, Tr am200.	
	EC-058	一体式心电导联线, 三导, 夹式, 美标 ECG CABLE, 3LD, CLIP, AHA		
	EC-059	一体式心电导联线, 三导, 扣式, 欧标 ECG CABLE, 3LD, SNAP, IEC		
	EC-060	一体式心电导联线, 三导, 夹式, 欧标 ECG CABLE, 3LD, CLIP, IEC		



本公司所有网站, 彩页所涉及到的图片, 文件, 商标, 版权均属于原作者, 本处出于产品说明需要而引用, 绝无它用

公司官方网站 : <http://www.touch-sz.com>



# 一体式监护心电电缆和导联线

## One-Piece Series Patient Cable With Leads

兼容品牌 Manufacturer	产品编号 P/N	产品描述 Product description	兼容型号 Compatibility Model	仪器端插头 Interface
马葵 GE-MEDIQUTTE	EC-061	一体式心电导联线, 五导, 扣式, 美标 ECG CABLE, 5LD, SNAP, AHA	GEMS: Dash PR04000, Dash PR03000, Dash PR02000, Dash PR01000, Eagle Systems, MAC-Lab, Solar9500, Solar8000, Solar3000, Tram100, Tram200.	
	EC-062	一体式心电导联线, 五导, 夹式, 美标 ECG CABLE, 5LD, CLIP, AHA		
	EC-063	一体式心电导联线, 五导, 扣式, 欧标 ECG CABLE, 5LD, SNAP, IEC		
	EC-064	一体式心电导联线, 五导, 夹式, 欧标 ECG CABLE, 5LD, CLIP, IEC		
海力格 HELLIGE	EC-065	一体式心电导联线, 三导, 扣式, 美标 ECG CABLE, 3LD, SNAP, AHA	Hellige, Servomed 4, Generation, SCP 851, SCP 852, SCP 844, SCS 804, CardioServ, VICOM-sm.	
	EC-066	一体式心电导联线, 三导, 夹式, 美标 ECG CABLE, 3LD, CLIP, AHA		
	EC-067	一体式心电导联线, 三导, 扣式, 欧标 ECG CABLE, 3LD, SNAP, IEC		
	EC-068	一体式心电导联线, 三导, 夹式, 欧标 ECG CABLE, 3LD, CLIP, IEC		
	EC-069	一体式心电导联线, 五导, 扣式, 美标 ECG CABLE, 5LD, SNAP, AHA		
	EC-070	一体式心电导联线, 五导, 夹式, 美标 ECG CABLE, 5LD, CLIP, AHA		
	EC-071	一体式心电导联线, 五导, 扣式, 欧标 ECG CABLE, 5LD, SNAP, IEC		
	EC-072	一体式心电导联线, 五导, 夹式, 欧标 ECG CABLE, 5LD, CLIP, IEC		
康强 KONTRON	EC-073	一体式心电导联线, 三导, 扣式, 美标 ECG CABLE, 3LD, SNAP, AHA	7000, 7135, 7135B, 7141, 7210, 7250, 7251, K2000, KAAT	
	EC-074	一体式心电导联线, 三导, 夹式, 美标 ECG CABLE, 3LD, CLIP, AHA		
	EC-075	一体式心电导联线, 三导, 扣式, 欧标 ECG CABLE, 3LD, SNAP, IEC		
	EC-076	一体式心电导联线, 三导, 夹式, 欧标 ECG CABLE, 3LD, CLIP, IEC		
	EC-077	一体式心电导联线, 五导, 扣式, 美标 ECG CABLE, 5LD, SNAP, AHA		
	EC-078	一体式心电导联线, 五导, 夹式, 美标 ECG CABLE, 5LD, CLIP, AHA		
	EC-079	一体式心电导联线, 五导, 扣式, 欧标 ECG CABLE, 5LD, SNAP, IEC		
	EC-080	一体式心电导联线, 五导, 夹式, 欧标 ECG CABLE, 5LD, CLIP, IEC		

本公司所有网站, 彩页所涉及到的图片, 文件, 商标, 版权均属于原作者, 本处出于产品说明需要而引用, 绝无它用



公司官方网站 : <http://www.touch-sz.com>





# 一体式监护心电电缆和导联线

## One-Piece Series Patient Cable With Leads

兼容品牌 Manufacturer	产品编号 P/N	产品描述 Product description	兼容型号 Compatibility Model	仪器端插头 Interface
印度 L&T	EC-081	一体式心电导联线, 三导, 扣式, 美标 ECG CABLE, 3LD, SNAP, AHA	DLanet50	
	EC-082	一体式心电导联线, 三导, 夹式, 美标 ECG CABLE, 3LD, CLIP, AHA		
	EC-083	一体式心电导联线, 三导, 扣式, 欧标 ECG CABLE, 3LD, SNAP, IEC		
	EC-084	一体式心电导联线, 三导, 夹式, 欧标 ECG CABLE, 3LD, CLIP, IEC		
美敦力 MEDTRONIC	EC-085	一体式心电导联线, 三导, 扣式, 美标 ECG CABLE, 3LD, SNAP, AHA	Lifepak 12, 120, Lifepak 20	
	EC-086	一体式心电导联线, 三导, 夹式, 美标 ECG CABLE, 3LD, CLIP, AHA		
	EC-087	一体式心电导联线, 三导, 扣式, 欧标 ECG CABLE, 3LD, SNAP, IEC		
	EC-088	一体式心电导联线, 三导, 夹式, 欧标 ECG CABLE, 3LD, CLIP, IEC		
	EC-089	一体式心电导联线, 五导, 扣式, 美标 ECG CABLE, 5LD, SNAP, AHA		
	EC-090	一体式心电导联线, 五导, 夹式, 美标 ECG CABLE, 5LD, CLIP, AHA		
	EC-091	一体式心电导联线, 五导, 扣式, 欧标 ECG CABLE, 5LD, SNAP, IEC		
	EC-092	一体式心电导联线, 五导, 夹式, 欧标 ECG CABLE, 5LD, CLIP, IEC		
美克 MEK	EC-093	一体式心电导联线, 三导, 扣式, 美标 ECG CABLE, 3LD, SNAP, AHA	MP1000, MP600, MP500	
	EC-094	一体式心电导联线, 三导, 夹式, 美标 ECG CABLE, 3LD, CLIP, AHA		
	EC-095	一体式心电导联线, 三导, 扣式, 欧标 ECG CABLE, 3LD, SNAP, IEC		
	EC-096	一体式心电导联线, 三导, 夹式, 欧标 ECG CABLE, 3LD, CLIP, IEC		
	EC-097	一体式心电导联线, 五导, 扣式, 美标 ECG CABLE, 5LD, SNAP, AHA		
	EC-098	一体式心电导联线, 五导, 夹式, 美标 ECG CABLE, 5LD, CLIP, AHA		
	EC-099	一体式心电导联线, 五导, 扣式, 欧标 ECG CABLE, 5LD, SNAP, IEC		
	EC-100	一体式心电导联线, 五导, 夹式, 欧标 ECG CABLE, 5LD, CLIP, IEC		



本公司所有网站, 彩页所涉及到的图片, 文件, 商标, 版权均属于原作者, 本处出于产品说明需要而引用, 绝无它用

公司官方网站 : <http://www.touch-sz.com>



# 一体式监护心电电缆和导联线

## One-Piece Series Patient Cable With Leads

兼容品牌 Manufacturer	产品编号 P/N	产品描述 Product description	兼容型号 Compatibility Model	仪器端插头 Interface
美能 MENEN	EC-101	一体式心电导联线, 三导, 扣式, 美标 ECG CABLE, 3LD, SNAP, AHA	Horizon 250, 3000, 450, Microsolo , 936 Series, 425/101, Preamp, Cardio- Pak2000, 740, 741742	
	EC-102	一体式心电导联线, 三导, 夹式, 美标 ECG CABLE, 3LD, CLIP, AHA		
	EC-103	一体式心电导联线, 三导, 扣式, 欧标 ECG CABLE, 3LD, SNAP, IEC		
	EC-104	一体式心电导联线, 三导, 夹式, 欧标 ECG CABLE, 3LD, CLIP, IEC		
	EC-105	一体式心电导联线, 五导, 扣式, 美标 ECG CABLE, 5LD, SNAP, AHA		
	EC-106	一体式心电导联线, 五导, 夹式, 美标 ECG CABLE, 5LD, CLIP, AHA		
	EC-107	一体式心电导联线, 五导, 扣式, 欧标 ECG CABLE, 5LD, SNAP, IEC		
	EC-108	一体式心电导联线, 五导, 夹式, 欧标 ECG CABLE, 5LD, CLIP, IEC		
美能 MENEN	EC-109	一体式心电导联线, 三导, 扣式, 美标 ECG CABLE, 3LD, SNAP, AHA	MENEN: 900, 1100, 1110, Ho rizon2000, 2100, 2200, 52 00, Horizon, 9000XL, MR12 00, 1270Horizon1280, 130 0, Horizon1380	
	EC-110	一体式心电导联线, 三导, 夹式, 美标 ECG CABLE, 3LD, CLIP, AHA		
	EC-111	一体式心电导联线, 三导, 扣式, 欧标 ECG CABLE, 3LD, SNAP, IEC		
	EC-112	一体式心电导联线, 三导, 夹式, 欧标 ECG CABLE, 3LD, CLIP, IEC		
	EC-113	一体式心电导联线, 五导, 扣式, 美标 ECG CABLE, 5LD, SNAP, AHA		
	EC-114	一体式心电导联线, 五导, 夹式, 美标 ECG CABLE, 5LD, CLIP, AHA		
	EC-115	一体式心电导联线, 五导, 扣式, 欧标 ECG CABLE, 5LD, SNAP, IEC		
	EC-116	一体式心电导联线, 五导, 夹式, 欧标 ECG CABLE, 5LD, CLIP, IEC		
NEC	EC-117	一体式心电导联线, 三导, 扣式, 美标 ECG CABLE, 3LD, SNAP, AHA	3M12	
	EC-118	一体式心电导联线, 三导, 夹式, 美标 ECG CABLE, 3LD, CLIP, AHA		
	EC-119	一体式心电导联线, 三导, 扣式, 欧标 ECG CABLE, 3LD, SNAP, IEC		
	EC-120	一体式心电导联线, 三导, 夹式, 欧标 ECG CABLE, 3LD, CLIP, IEC		

本公司所有网站, 彩页所涉及到的图片, 文件, 商标, 版权均属于原作者, 本处出于产品说明需要而引用, 绝无它用

公司官方网站 : <http://www.touch-sz.com>



# 一体式监护心电电缆和导联线

## One-Piece Series Patient Cable With Leads

兼容品牌 Manufacturer	产品编号 P/N	产品描述 Product description	兼容型号 Compatibility Model	仪器端插头 Interface
NEC	EC-121	一体式心电导联线, 五导, 扣式, 美标 ECG CABLE, 5LD, SNAP, AHA	3M12	
	EC-122	一体式心电导联线, 五导, 夹式, 美标 ECG CABLE, 5LD, CLIP, AHA		
	EC-123	一体式心电导联线, 五导, 扣式, 欧标 ECG CABLE, 5LD, SNAP, IEC		
	EC-124	一体式心电导联线, 五导, 夹式, 欧标 ECG CABLE, 5LD, CLIP, IEC		
日本光电 NINOH KOHDEN	EC-125	一体式心电导联线, 三导, 扣式, 美标 ECG CABLE, 3LD, SNAP, AHA	OEC- 6102A (sn<20226), OEC610 5A (sn<20226), OEC- 6120A/J/K	
	EC-126	一体式心电导联线, 三导, 夹式, 美标 ECG CABLE, 3LD, CLIP, AHA		
	EC-127	一体式心电导联线, 三导, 扣式, 欧标 ECG CABLE, 3LD, SNAP, IEC		
	EC-128	一体式心电导联线, 三导, 夹式, 欧标 ECG CABLE, 3LD, CLIP, IEC		
	EC-129	一体式心电导联线, 五导, 扣式, 美标 ECG CABLE, 5LD, SNAP, AHA		
	EC-130	一体式心电导联线, 五导, 夹式, 美标 ECG CABLE, 5LD, CLIP, AHA		
	EC-131	一体式心电导联线, 五导, 扣式, 欧标 ECG CABLE, 5LD, SNAP, IEC		
	EC-132	一体式心电导联线, 五导, 夹式, 欧标 ECG CABLE, 5LD, CLIP, IEC		
日本光电 NINOH KOHDEN	EC-133	一体式心电导联线, 三导, 扣式, 美标 ECG CABLE, 3LD, SNAP, AHA	BSM-7102A, OMP- 7201C, OMP-7203C, TEC- 5200A (s/n<20421)	
	EC-134	一体式心电导联线, 三导, 夹式, 美标 ECG CABLE, 3LD, CLIP, AHA		
	EC-135	一体式心电导联线, 三导, 扣式, 欧标 ECG CABLE, 3LD, SNAP, IEC		
	EC-136	一体式心电导联线, 三导, 夹式, 欧标 ECG CABLE, 3LD, CLIP, IEC		
	EC-137	一体式心电导联线, 五导, 扣式, 美标 ECG CABLE, 5LD, SNAP, AHA	TEC-7621C	
	EC-138	一体式心电导联线, 五导, 夹式, 美标 ECG CABLE, 5LD, CLIP, AHA		
	EC-139	一体式心电导联线, 五导, 扣式, 欧标 ECG CABLE, 5LD, SNAP, IEC		
	EC-140	一体式心电导联线, 五导, 夹式, 欧标 ECG CABLE, 5LD, CLIP, IEC		



本公司所有网站, 彩页所涉及到的图片, 文件, 商标, 版权均属于原作者, 本处出于产品说明需要而引用, 绝无它用

公司官方网站 : <http://www.touch-sz.com>



# 一体式监护心电电缆和导联线

## One-Piece Series Patient Cable With Leads

兼容品牌 Manufacturer	产品编号 P/N	产品描述 Product description	兼容型号 Compatibility Model	仪器端插头 Interface
飞利浦 PHILIPS	EC-141	一体式心电导联线, 三导, 扣式, 美标 ECG CABLE, 3LD, SNAP, AHA	4310A/43110A/43110M/43120A/43200A Portable, M3500B, 77000A C, 77020A/AC, 77010AC, So nos2000/2500/AC/AR, 770 25A, 77030A, 77035A, 7704 0A, 78208A, 78210A, 78330 A	
	EC-142	一体式心电导联线, 三导, 夹式, 美标 ECG CABLE, 3LD, CLIP, AHA		
	EC-143	一体式心电导联线, 三导, 扣式, 欧标 ECG CABLE, 3LD, SNAP, IEC		
	EC-144	一体式心电导联线, 三导, 夹式, 欧标 ECG CABLE, 3LD, CLIP, IEC		
	EC-145	一体式心电导联线, 五导, 扣式, 美标 ECG CABLE, 5LD, SNAP, AHA		
	EC-146	一体式心电导联线, 五导, 夹式, 美标 ECG CABLE, 5LD, CLIP, AHA		
	EC-147	一体式心电导联线, 五导, 扣式, 欧标 ECG CABLE, 5LD, SNAP, IEC		
	EC-148	一体式心电导联线, 五导, 夹式, 欧标 ECG CABLE, 5LD, CLIP, IEC		
飞利浦 PHILIPS	EC-149	一体式心电导联线, 三导, 扣式, 美标 ECG CABLE, 3LD, SNAP, AHA	78352C, 7834C, 78834C, M1 001A/B, M1002A/B, M1722A /BM1723A/B, M2475B, M300 0A, M3001A, M4735A	
	EC-150	一体式心电导联线, 三导, 夹式, 美标 ECG CABLE, 3LD, CLIP, AHA		
	EC-151	一体式心电导联线, 三导, 扣式, 欧标 ECG CABLE, 3LD, SNAP, IEC		
	EC-152	一体式心电导联线, 三导, 夹式, 欧标 ECG CABLE, 3LD, CLIP, IEC		
	EC-153	一体式心电导联线, 五导, 扣式, 美标 ECG CABLE, 5LD, SNAP, AHA		
	EC-154	一体式心电导联线, 五导, 夹式, 美标 ECG CABLE, 5LD, CLIP, AHA		
	EC-155	一体式心电导联线, 五导, 扣式, 欧标 ECG CABLE, 5LD, SNAP, IEC		
	EC-156	一体式心电导联线, 五导, 夹式, 欧标 ECG CABLE, 5LD, CLIP, IEC		
丹麦阿堤玛 S&W Artema	EC-157	一体式心电导联线, 三导, 扣式, 美标 ECG CABLE, 3LD, SNAP, AHA	8000 System, Diascope1, 2, Neo scope, DMS700, defibrill ator, Diascope- NT, Athena Systems, Cardio-Aid, DS Traveller, DSNT, DS1, DS2 , MCX/LS	
	EC-158	一体式心电导联线, 三导, 夹式, 美标 ECG CABLE, 3LD, CLIP, AHA		
	EC-159	一体式心电导联线, 三导, 扣式, 欧标 ECG CABLE, 3LD, SNAP, IEC		
	EC-160	一体式心电导联线, 三导, 夹式, 欧标 ECG CABLE, 3LD, CLIP, IEC		

本公司所有网站, 彩页所涉及到的图片, 文件, 商标, 版权均属于原作者, 本处出于产品说明需要而引用, 绝无它用

公司官方网站 : <http://www.touch-sz.com>



# 一体式监护心电电缆和导联线

## One-Piece Series Patient Cable With Leads

兼容品牌 Manufacturer	产品编号 P/N	产品描述 Product description	兼容型号 Compatibility Model	仪器端插头 Interface
丹麦阿堤玛 S&W Artema	EC-161	一体式心电导联线, 五导, 扣式, 美标 ECG CABLE, 5LD, SNAP, AHA	8000 System, Diascope1, 2, Neo scope, DMS700, defibrill ator, Diascope- NT, Athena Systems, Cardio-Aid, DS Traveller, DSNT, DS1, DS2 , MCX/LS	
	EC-162	一体式心电导联线, 五导, 夹式, 美标 ECG CABLE, 5LD, CLIP, AHA		
	EC-163	一体式心电导联线, 五导, 扣式, 欧标 ECG CABLE, 5LD, SNAP, IEC		
	EC-164	一体式心电导联线, 五导, 夹式, 欧标 ECG CABLE, 5LD, CLIP, IEC		
西门子 SIEMENS	EC-165	一体式心电导联线, 三导, 扣式, 美标 ECG CABLE, 3LD, SNAP, AHA	Sirecust Series 400, 500, 600, Serie 700, 900, 1200, Sirecust 341/610/620, 630/720/72 2/, Sirecust 730/732/900/960/961/12 60, Sirecust 1281/1801/400/-500	
	EC-166	一体式心电导联线, 三导, 夹式, 美标 ECG CABLE, 3LD, CLIP, AHA		
	EC-167	一体式心电导联线, 三导, 扣式, 欧标 ECG CABLE, 3LD, SNAP, IEC		
	EC-168	一体式心电导联线, 三导, 夹式, 欧标 ECG CABLE, 3LD, CLIP, IEC		
	EC-169	一体式心电导联线, 五导, 扣式, 美标 ECG CABLE, 5LD, SNAP, AHA		
	EC-170	一体式心电导联线, 五导, 夹式, 美标 ECG CABLE, 5LD, CLIP, AHA		
	EC-171	一体式心电导联线, 五导, 扣式, 欧标 ECG CABLE, 5LD, SNAP, IEC		
	EC-172	一体式心电导联线, 五导, 夹式, 欧标 ECG CABLE, 5LD, CLIP, IEC		
太空 SPACELABS	EC-173	一体式心电导联线, 三导, 扣式, 美标 ECG CABLE, 3LD, SNAP, AHA	90496 Ultraview, 90369, ULTRAV IEW, 90367 Ultraview	
	EC-174	一体式心电导联线, 三导, 夹式, 美标 ECG CABLE, 3LD, CLIP, AHA		
	EC-175	一体式心电导联线, 三导, 扣式, 欧标 ECG CABLE, 3LD, SNAP, IEC		
	EC-176	一体式心电导联线, 三导, 夹式, 欧标 ECG CABLE, 3LD, CLIP, IEC		
	EC-177	一体式心电导联线, 五导, 扣式, 美标 ECG CABLE, 5LD, SNAP, AHA		
	EC-178	一体式心电导联线, 五导, 夹式, 美标 ECG CABLE, 5LD, CLIP, AHA		
	EC-179	一体式心电导联线, 五导, 扣式, 欧标 ECG CABLE, 5LD, SNAP, IEC		
	EC-180	一体式心电导联线, 五导, 夹式, 欧标 ECG CABLE, 5LD, CLIP, IEC		



本公司所有网站, 彩页所涉及到的图片, 文件, 商标, 版权均属于原作者, 本处出于产品说明需要而引用, 绝无它用

公司官方网站 : <http://www.touch-sz.com>



# 一体式监护心电电缆和导联线

## One-Piece Series Patient Cable With Leads

兼容品牌 Manufacturer	产品编号 P/N	产品描述 Product description	兼容型号 Compatibility Model	仪器端插头 Interface
金科威 GOLDWAY	EC-181	一体式心电导联线, 三导, 扣式, 美标 ECG CABLE, 3LD, SNAP, AHA	UT4000A, UT4000Apro, UT6000A, UT4000B, UT4000C, UT4000F, UT6000F, UT4000Fpro, UT4800	
	EC-182	一体式心电导联线, 三导, 夹式, 美标 ECG CABLE, 3LD, CLIP, AHA		
	EC-183	一体式心电导联线, 三导, 扣式, 欧标 ECG CABLE, 3LD, SNAP, IEC		
	EC-184	一体式心电导联线, 三导, 夹式, 欧标 ECG CABLE, 3LD, CLIP, IEC		
	EC-185	一体式心电导联线, 五导, 扣式, 美标 ECG CABLE, 5LD, SNAP, AHA		
	EC-186	一体式心电导联线, 五导, 夹式, 美标 ECG CABLE, 5LD, CLIP, AHA		
	EC-187	一体式心电导联线, 五导, 扣式, 欧标 ECG CABLE, 5LD, SNAP, IEC		
	EC-188	一体式心电导联线, 五导, 夹式, 欧标 ECG CABLE, 5LD, CLIP, IEC		
迈瑞	EC-189	一体式心电导联线, 三导, 扣式, 美标 ECG CABLE, 3LD, SNAP, AHA	PM9000, PM8000, PM7000	
	EC-190	一体式心电导联线, 三导, 夹式, 美标 ECG CABLE, 3LD, CLIP, AHA		
	EC-191	一体式心电导联线, 三导, 扣式, 欧标 ECG CABLE, 3LD, SNAP, IEC		
	EC-192	一体式心电导联线, 三导, 夹式, 欧标 ECG CABLE, 3LD, CLIP, IEC		
	EC-193	一体式心电导联线, 五导, 扣式, 美标 ECG CABLE, 5LD, SNAP, AHA		
	EC-194	一体式心电导联线, 五导, 夹式, 美标 ECG CABLE, 5LD, CLIP, AHA		
	EC-195	一体式心电导联线, 五导, 扣式, 欧标 ECG CABLE, 5LD, SNAP, IEC		
	EC-196	一体式心电导联线, 五导, 夹式, 欧标 ECG CABLE, 5LD, CLIP, IEC		



# 分体式监护心电电缆和导联线

## Two-Piece Series Patient Cable With Leads



### 设备端连接器:

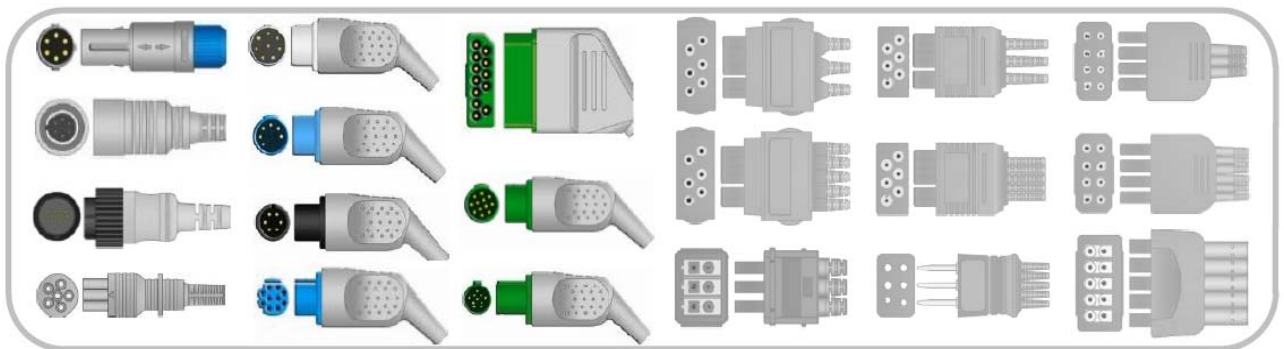



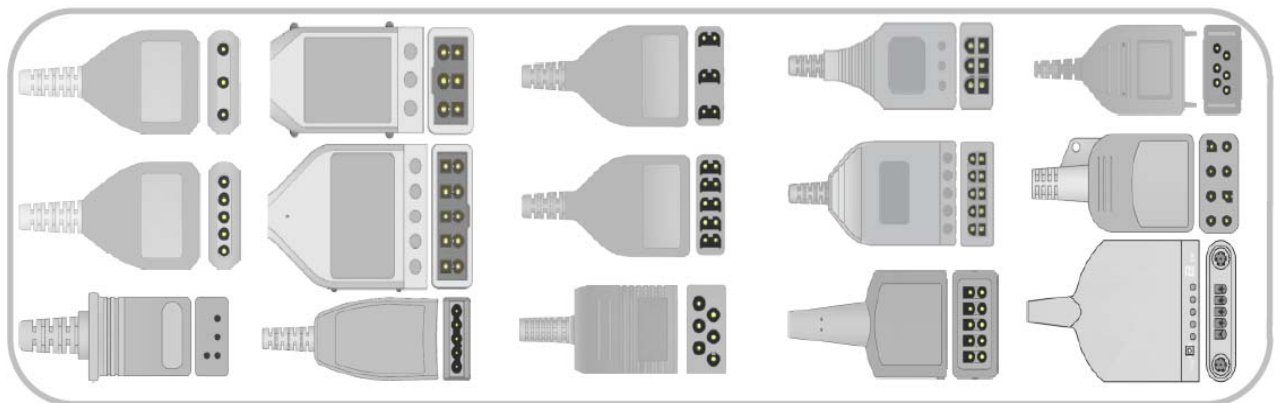















### 分线器:





# 分体式监护心电电缆和导联线

## Two-Piece Series Patient Cable With Leads

兼容品牌 Manufacturer	产品编号 P/N	产品描述 Product description	兼容仪器型号 Compatibility	仪器端插头 Interface	
BIONET (韩国品牌)	OE-001	三导监护心电电缆, 圆形8针插头 & 三导分线器, L=9ft, 1K $\Omega$ 电阻, (AHA/IEC)	BM3		
	OE-002	五导监护心电电缆, 圆形8针插头 & 五导分线器, L=9ft, 1K $\Omega$ 电阻, (AHA/IEC)	BM3		
BIONET (韩国品牌)	OE-003	三导监护心电电缆, 圆形8针插头 & 三导分线器, L=9ft, 1K $\Omega$ 电阻, (AHA/IEC)	BPM-103		
	OE-004	五导监护心电电缆, 圆形8针插头 & 五导分线器, L=9ft, 1K $\Omega$ 电阻, (AHA/IEC)	BPM-103		
科林 COLIN	OE-005	五导监护心电电缆, 6P圆形插头 & 6孔分线器, L=9ft, (AHA/IEC)	Colin:BP88/BP306		
	OE-006	五导监护心电电缆, 6P圆形插头 & 6孔分线器, L=9ft, (AHA/IEC)	Colin:BP88S		
德恩 DATEX	OE-007	三导监护心电电缆, 10针圆孔插头 & 三导分线器, L=9ft (AHA/IEC), 4.7K $\Omega$ 电阻	AS/3, CS/3, S/5, Cardiocap 1, Cardiocap 2, Cardiocap 5, Light Monitor, Satliteplus		
	OE-008	五导监护心电电缆, 10针圆孔插头 & 五导分线器, L=9ft (AHA/IEC), 4.7K $\Omega$ 电阻			
通用医疗-马 葵 GE-MEDICAL MARQUETTE	OE-009	五导监护心电电缆, 方形11针插头 & 五导分线器, L=9ft (AHA/IEC)	GEMS: Dash PRO4000, Dash PRO 3000, Dash 1000, Eagle Systems, MAC-Lab, Solar 9500, Solar 8000, Solar 3000, Tram 100, Tram 200, Tram 300, Tram 400, Tram 500, Tram 600, Tram 800		

本公司所有网站, 彩页所涉及到的图片, 文件, 商标, 版权均属于原作者, 本处出于产品说明需要而引用, 绝无它用









公司官方网站 : <http://www.touch-sz.com>





# 分体式监护心电电缆和导联线

## Two-Piece Series Patient Cable With Leads

海力格 GE-Hellige	OE-010	五导监护心电电缆, 圆形10针插头 & 五导分线器, L=9ft, (AHA/IEC)	Hellige, Servomed 4, Generation, SCP 851, SCP 852, SCP 844, SCP804, CardioSery, VICOM-sm		
	OE-011	三导监护心电电缆, 圆形10针插头 & 三导分线器, L=9ft, (AHA/IEC)			
	OE-012	五导监护心电电缆, 圆形10针插头 & 五导分线器, L=9ft, (AHA/IEC)			
康强 KONTRON	OE-013	三导监护心电电缆, 12P圆形插头 & 三导分线器, L=9ft, (AHA/IEC)	7000, 7135, 7135B, 7141, 7210, 7250, 7251, K2000, KAAT, Kolormon, Micromon, Minimon, Supermon, Vitalmon		
	OE-014	五导监护心电电缆, 12P圆形插头 & 五导分线器, L=9ft, (AHA/IEC)			
美克 MEK	OE-015	三导监护心电电缆, DB9M & 三导分线器, L=9ft, (AHA/IEC)	MP1000, MP600, MP500		
	OE-016	五导监护心电电缆, DB-9M & 五导分线器, L=9ft, (AHA/IEC)			
迈瑞 MINDRAY	OE-017	三导监护心电电缆, 圆形12针插头 & 三导分线器, L=9ft, (AHA/IEC), 1K电阻加防ESU电感	PM6000, with 12-pin green input connector		
	OE-018	五导监护心电电缆, 圆形12针插头 & 五导分线器, L=9ft, (AHA/IEC), 1K电阻加防ESU电感			
NEC	OE-019	三导监护心电电缆, 圆形16针插头 & 三导分线器, L=9ft, (AHA/IEC)	3M12		







本公司所有网站, 彩页所涉及到的图片, 文件, 商标, 版权均属于原作者, 本处出于产品说明需要而引用, 绝无它用

公司官方网站 : <http://www.touch-sz.com>

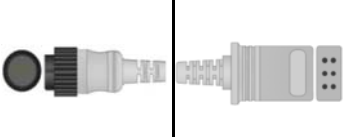

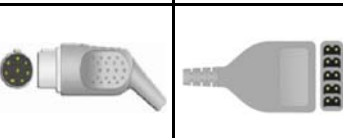
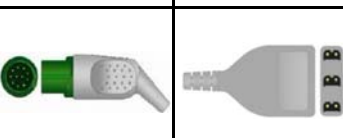
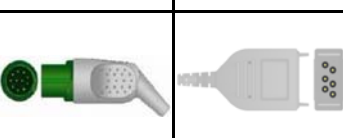
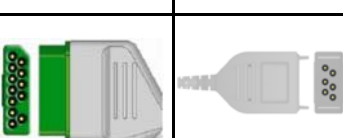
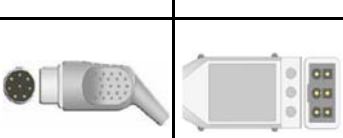
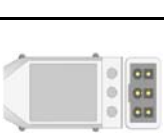
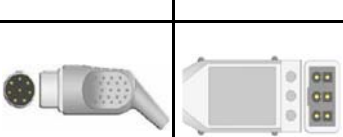
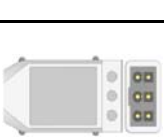
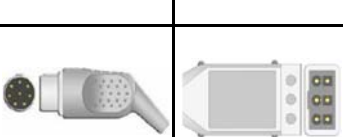
# 分体式监护心电电缆和导联线

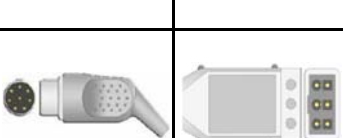
## Two-Piece Series Patient Cable With Leads

NEC	OE-020	五导监护心电电缆，圆形16针插头 & 五导分线器，L=9ft, (AHA/IEC)	3M12		
日本光电 NIHON KOHDEN	OE-021	三导监护心电电缆，圆形8针插头 & 三导分线器，L=9ft, (IEC)	0EC-6102A, (S/N<20156), 0		
日本光电 NIHON KOHDEN	OE-022	五导监护心电电缆，圆形8针插头 & 五导分线器，L=9ft, (IEC)	6105A (S/N<20226) 0EC-6120A/J/K		
日本光电 NIHON KOHDEN	OE-023	三导监护心电电缆，圆形8针插头 & 三导分线器，L=9ft, (IEC)	BSM-7102A, OMP-7201C, OMP-		
日本光电 NIHON KOHDEN	OE-024	五导监护心电电缆，圆形8针插头 & 五导分线器，L=9ft, (IEC)	7203C, TEC-5200A (S/N<20421)		
日本光电 NIHON KOHDEN	OE-025	六导监护心电电缆，方形12针插头 & 日本光电8孔插头，L=9ft, (IEC)	BSM-2301, BSM-2353, BSM-5100, Multi-parameter bedside monitors		
飞利浦 PHILIPS	OE-026	三导监护心电电缆，圆形8针插头 & 三导分线器，L=9ft, 1KΩ电阻, (AHA)	77000AC, 77020A/AC, 77020AR, 77025A, 77030A, 77035A, 77040A, 78208A, 78210A, 78330A, 78331A, 78332A, 78333A, 78341A, 78332A, 78333A, 78341A, 78342A, 78345A, 78346A, 78351T, 78352A, 78353A/B, 78354A, 78532A/B, 78534A/B/C, M1722A/B, M1723A/B, M1722A/B, M1723A/B, M2400A, M2406A, M2475B		
	OE-027	三导监护心电电缆，圆形8针插头 & 三导分线器，L=9ft, 1KΩ电阻, (IEC)			
	OE-028	五导监护心电电缆，圆形8针插头 & 五导分线器，L=9ft, 1KΩ电阻, (AHA)			
	OE-029	五导监护心电电缆，圆形8针插头 & 五导分线器，L=9ft, 1KΩ电阻, (IEC)			

本公司所有网站，彩页所涉及到的图片，文件，商标，版权均属于原作者，本处出于产品说明需要而引用，绝无它用

公司官方网站：<http://www.touch-sz.com>



# 分体式监护心电电缆和导联线

## Two-Piece Series Patient Cable With Leads

飞利浦 PHILIPS	OE-030	三导监护心电电缆，圆形12针插头 & 三导分线器, L=9ft, 1K $\Omega$ 电阻, (AHA)	78352C, 7834C, 78834C, M1001A/B, M1002A/B, M1722A/B, M1723A/B, M2475B, M3000A, M3001A, M4735A		
	OE-031	三导监护心电电缆，圆形8针插头 & 三导分线器, L=9ft, 1K $\Omega$ 电阻, (IEC)			
	OE-032	五导监护心电电缆，圆形8针插头 & 五导分线器, L=9ft, 1K $\Omega$ 电阻, (AHA)			
	OE-033	五导监护心电电缆，圆形8针插头 & 五导分线器, L=9ft, 1K $\Omega$ 电阻, (IEC)			
丹麦阿堤玛 S&W ARTEMA	OE-034	三导监护心电电缆，圆形10孔插头 & 三导分线器, L=9ft, (AHA)	8000 System, Diascope1, 2, Neoscope, DMS 700, defibrillator, Diascope-NT, Athena Systems, Cardio-Aid, DS Traveller, DSNT, DS1, DS2, MCX/LS		
	OE-035	五导监护心电电缆，圆形10孔插头 & 五导分线器, L=9ft, (IEC)			
西门子 SIEMENS	OE-036	三导监护心电电缆，圆形10孔插头 & 三导分线器, L=9ft, (AHA)	8000 System, Diascope1, 2, Neoscope, DMS 700, defibrillator, Diascope-NT, Athena Systems, Cardio-Aid, DS Traveller, DSNT, DS1, DS2, MCX/LS		
	OE-037	五导监护心电电缆，圆形10孔插头 & 五导分线器, L=9ft, (IEC)			
太空医疗 Spacelabs	OE-038	五导监护心电电缆，10P插头 & 五导分线器, L=9ft, (AHA)	90496 Ultraview, 90369 Ultraview, 90367 Ultraview		
DIN式监护心电电缆 (通用规格)	OE-039	DIN式三导监护心电电缆，6P插头 & 三导分线器, L=9ft, (AHA/IEC)	DIN通用型		

本公司所有网站, 彩页所涉及到的图片, 文件, 商标, 版权均属于原作者, 本处出于产品说明需要而引用, 绝无它用

公司官方网站 : <http://www.touch-sz.com>



# 分体式监护心电电缆和导联线

## Two-Piece Series Patient Cable With Leads

DIN式监护心电电缆 (通用规格)	OE-040	DIN式五导监护心电电缆, 6P插头 & 五导分线器, L=9ft, (IEC)	DIN通用型		
	OE-041	DIN式三导监护心电电缆, 6P插头 & 三导分线器, L=9ft, 1KΩ电阻, (AHA/IEC)			
	OE-042	DIN式五导监护心电电缆, 6P插头 & 五导分线器, L=9ft, 1KΩ电阻, (AHA/IEC)			
Lifeline LL式监护心电电缆 (通用规格)	OE-043	LL式三导监护心电电缆, 6P插头 & 三导分线器, L=9ft, (AHA)	LL通用型		
	OE-044	LL式五导监护心电电缆, 6P插头 & 五导分线器, L=9ft, (IEC)			
	OE-045	LL式三导监护心电电缆, 6P插头 & 三导分线器, L=9ft, (AHA)			
	OE-046	LL式五导监护心电电缆, 6P插头 & 五导分线器, L=9ft, (IEC)			
DIN式导联分线 (通用规格)	OE-047	DIN式三导联分线, 扣式, 美标, (AHA), L=45cm	与所有DIN式分线器的主缆匹配		
	OE-048	DIN式三导联分线, 夹式, 美标, (AHA), L=45cm			
	OE-049	DIN式五导联分线, 扣式, 美标, (AHA), L=45cm			

本公司所有网站, 彩页所涉及到的图片, 文件, 商标, 版权均属于原作者, 本处出于产品说明需要而引用, 绝无它用  
公司官方网站 : <http://www.touch-sz.com>



# 分体式监护心电电缆和导联线

## Two-Piece Series Patient Cable With Leads

DIN式导联分线 (通用规格)	OE-050	DIN式五导联分线, 夹式, 美标, (AHA), L=45cm	与所有DIN式分线器的主缆匹配		
	OE-051	DIN式三导联分线, 扣式, 欧标, (IEC), L=45cm			
	OE-052	DIN式三导联分线, 夹式, 欧标, (IEC), L=45cm			
	OE-053	DIN式五导联分线, 扣式, 欧标, (IEC), L=45cm			
	OE-054	DIN式五导联分线, 夹式, 欧标, (IEC), L=45cm			
LL式导联分线 (通用规格)	OE-055	LL式三导联分线, 扣式, 美标, (AHA), L=63cm	与所有LL式分线器的主缆匹配		
	OE-056	LL式三导联分线, 夹式, 美标, (AHA), L=63cm			
	OE-057	LL式五导联分线, 扣式, 美标, (AHA), L=63cm			
	OE-058	DIN式五导联分线, 夹式, 美标, (AHA), L=63cm			
	OE-059	DIN式三导联分线, 扣式, 欧标, (IEC), L=63cm			

本公司所有网站, 彩页所涉及到的图片, 文件, 商标, 版权均属于原作者, 本处出于产品说明需要而引用, 绝无它用

公司官方网站 : <http://www.touch-sz.com>



# 分体式监护心电电缆和导联线

## Two-Piece Series Patient Cable With Leads

LL式导联分线 (通用规格)	OE-060	DIN式三导联分线, 夹式, 欧标, (IEC), L=63cm	与所有LL式分线器的主缆匹配		
	OE-061	DIN式五导联分线, 扣式, 欧标, (IEC), L=63cm			
	OE-062	DIN式五导联分线, 夹式, 欧标, (IEC), L=63cm			
ASP型导联分线 德恩-欧美达 DATEX-OHMEDA GE-MEDICAL PRO1000	OE-063	ASP三导联分线, 扣式, 美标/欧标, (AHA/IEC), L=63cm	与所有ASP分线器的主缆匹配		
	OE-064	ASP三导联分线, 夹式, 美标/欧标, (AHA/IEC), L=63cm			
	OE-065	ASP五导联分线, 扣式, 美标/欧标, (AHA/IEC), L=63cm			
	OE-066	ASP五导联分线, 夹式, 美标/欧标, (AHA/IEC), L=63cm			
VS型导联分线 GE-MEDICAL MARQUETTE	OE-067	VS型五导联分线(不可拆分), 扣式, 美标/欧标 (AHA/IEC), L=76cm	GEMS: Dash PRO 4000, Dash PRO 3000, Dash PRO 2000, Dash PRO 1000, Eagle Systems, MAC-Lab, Solar 9500, Solar 8000, Solar 3000, Tram 100, Tram 200,		
	OE-068	VS型五导联分线, 夹式, (不可拆分), 美标/欧标, (AHA/IEC), L=76cm			
	OE-069	VS型五导联分线(不可拆分), 扣式, 美标/欧标 (AHA/IEC), L=130cm			

本公司所有网站, 彩页所涉及到的图片, 文件, 商标, 版权均属于原作者, 本处出于产品说明需要而引用, 绝无它用  
公司官方网站 : <http://www.touch-sz.com>



# 分体式监护心电电缆和导联线

## Two-Piece Series Patient Cable With Leads

VS型导联分线 GE-MEDICAL MARQUETTE	OE-070	VS型五导联分线, (不可拆分), 夹式, 美标/欧标, (AHA/IEC), L=130cm	Tram 300, Tram 400, Tram 500, Tram 600, Tram 800,		
VS型导联分线 GE-MEDICAL MARQUETTE	OE-071	AA型三导联分线, 扣式, 美标/欧标 (AHA/IEC), L=102cm	suitable for all AA-Plus System, Yoke type: AA style includes special filtering; does not allow respiration monitoring		
	OE-072	AA型三导联分线, 夹式, 美标/欧标, (AHA/IEC), L=102cm			
	OE-073	AA型五导联分线, 扣式, 美标/欧标 (AHA/IEC), L=102cm			
	OE-074	VS型五导联分线, 夹式, 美标/欧标, (AHA/IEC), L=102cm			
太空 SPACELABS	OE-075	太空TUR-LINK型三导联分线, 扣式, 美标/欧标 (AHA/IEC), L=61cm	90496 Ultraview, 90369 Ultraview, 90367 Ultraview		
	OE-076	太空TUR-LINK型三导联分线, 夹式, 美标/欧标 (AHA/IEC), L=61cm			
	OE-077	太空TUR-LINK型五导联分线, 扣式, 美标/欧标 (AHA/IEC), L=61cm			
	OE-078	太空TUR-LINK型五导联分线, 夹式, 美标/欧标 (AHA/IEC), L=61cm			
科林 COLIN	OE-079	科林型三导联分线, 扣式, 欧标 (IEC), L=102cm	BP88/BP88S/BP306		

本公司所有网站, 彩页所涉及到的图片, 文件, 商标, 版权均属于原作者, 本处出于产品说明需要而引用, 绝无它用

公司官方网站 : <http://www.touch-sz.com>



# 分体式监护心电电缆和导联线

## Two-Piece Series Patient Cable With Leads

科林 COLIN	OE-080	科林型三导联分线, 夹式, 欧标 (IEC), L=102cm	BP88/BP88S/BP306		
	OE-081	科林型三导联分线, 扣式, 欧标 (IEC), L=102cm			
	OE-082	科林型三导联分线, 夹式, 欧标 (IEC), L=102cm			
日本光电 NIHON KOHDEN	OE-083	日本光电型三导联分线, 扣式, 欧标 (IEC), L=80cm			
	OE-084	日本光电型三导联分线, 夹式, 欧标 (IEC), L=80cm			
	OE-085	日本光电型五导联分线, 扣式, 欧标 (IEC), L=80cm			
	OE-086	日本光电型五导联分线, 夹式, 欧标 (IEC), L=80cm			
日本光电 NIHON KOHDEN	OE-087	日本光电型三导联分线, 扣式, 欧标 (IEC), L=90cm			
	OE-088	日本光电型三导联分线, 夹式, 欧标 (IEC), L=90cm			
	OE-089	日本光电型五导联分线, 扣式, 欧标 (IEC), L=90cm			

本公司所有网站, 彩页所涉及到的图片, 文件, 商标, 版权均属于原作者, 本处出于产品说明需要而引用, 绝无它用  
公司官方网站 : <http://www.touch-sz.com>





# 分体式监护心电电缆和导联线

## Two-Piece Series Patient Cable With Leads

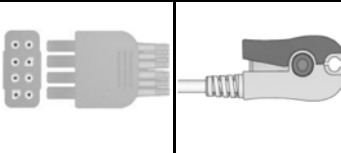
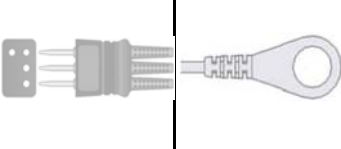
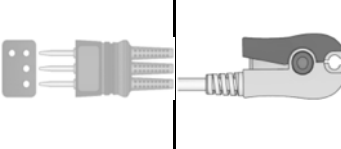
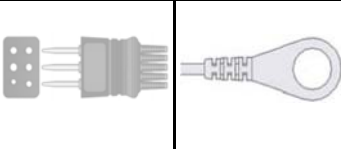
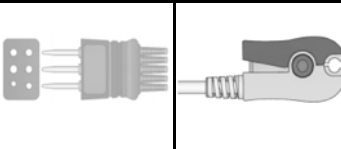
	OE-090	日本光电型五导联分线, 夹式, 欧标 (IEC), L=90cm		
NEC	OE-091	47504型三导联分线, 扣式, 欧标 (IEC), L=76cm		
	OE-092	47504型三导联分线, 夹式, 欧标 (IEC), L=76cm		
	OE-093	47504型五导联分线, 扣式, 欧标 (IEC), L=76cm		
	OE-094	47504型五导联分线, 夹式, 欧标 (IEC), L=76cm		



# 一体式心电图仪心电电缆和导联线 One-Piece Series EKG Cable With Leads

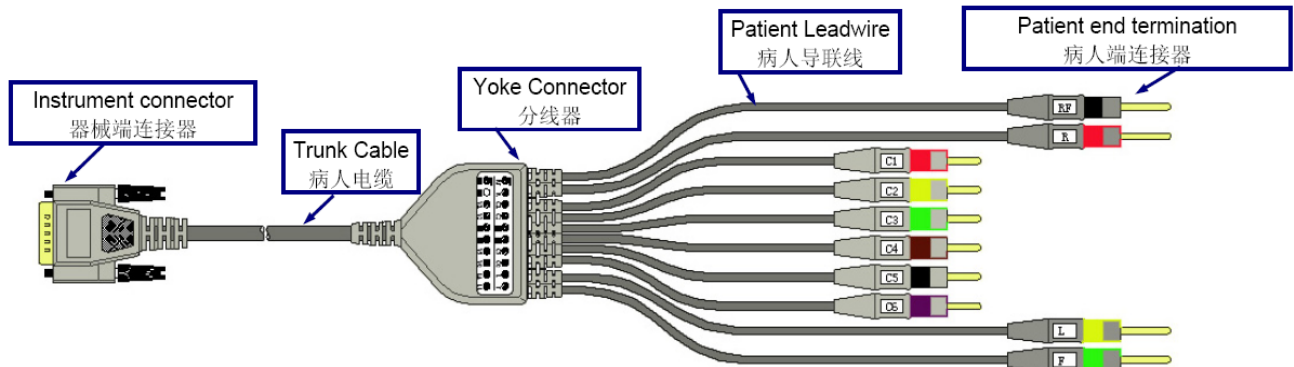

## 导联位置示意图

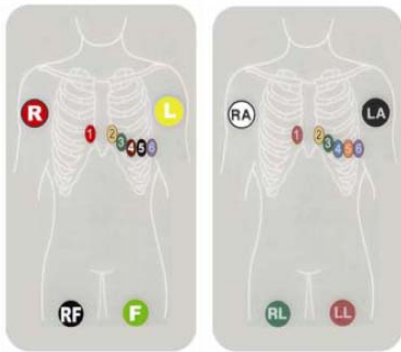

12 导:I  
欧洲标准

12 导:A  
美国标准 (AAMI)

## 仪器端连接器

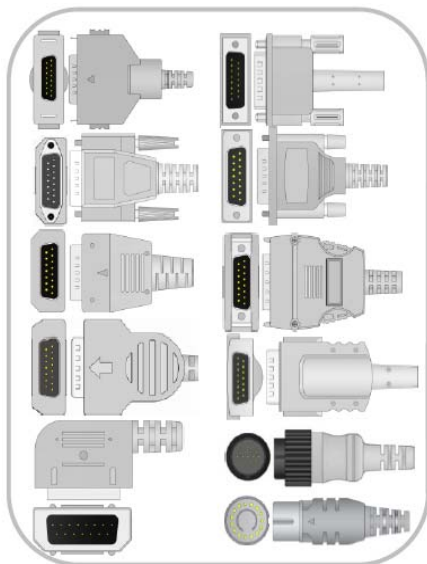

## 病人端电极连接器

S: 标准4.0按钮 (SNAP)



C: 夹式 (CLIP)



D: Din式3.0插针



B: 4.0香蕉插



## 病人端连接器

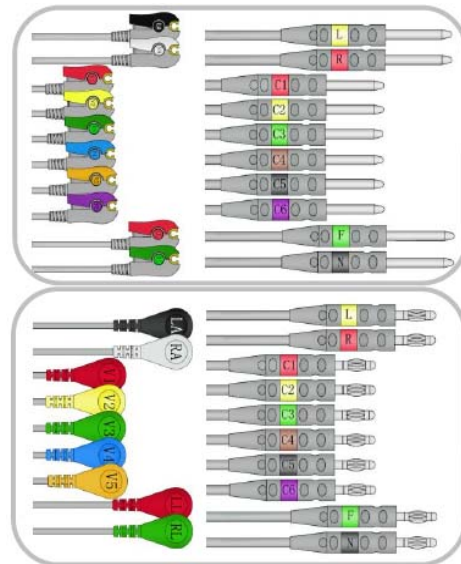



# 一体式心电图仪心电电缆和导联线

## One-Piece Series EKG Cable With Leads

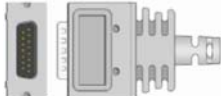
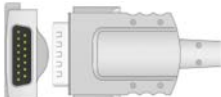
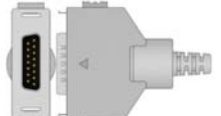
兼容品牌 Manufacturer	产品编号 P/N	产品描述 Product description	兼容型号 Compatibility	仪器端插头 Interface
伯迪克 BURDICK	EK-001	美标, 一体心电线, 扣式 AHA, EKG CABLE, SNAP	EK-10	
	EK-002	美标, 一体心电线, 夹式 AHA, EKG CABLE, CLIP		
	EK-003	美标, 一体心电线, 针式 AHA, EKG CABLE, DIN		
	EK-004	美标, 一体心电线, 香蕉插式 AHA, EKG CABLE, BANANA		
	EK-005	欧标, 一体心电线, 扣式 IEC, EKG CABLE, SNAP		
	EK-006	欧标, 一体心电线, 夹式 IEC, EKG CABLE, CLIP		
	EK-007	欧标, 一体心电线, 针式 IEC, EKG CABLE, DIN		
	EK-008	欧标, 一体心电线, 香蕉插式 IEC, EKG CABLE, BANANA		
伯迪克 BURDICK 昆腾 QUINTON ATRIA	EK-009	美标, 一体心电线, 扣式, 10K Ω AHA, EKG CABLE, SNAP, 10K Ω	Burdick (Quinton): Eclipse 4/8/400/ 800/850/850i , Eclipse Plus, Eclipse LE II Burdick with serial number starting with 1067 ou 92304, ATRIA: ATRIA PLUS ATRIA3000	
	EK-010	美标, 一体心电线, 夹式, 10K Ω AHA, EKG CABLE, CLIP, 10K Ω		
	EK-011	美标, 一体心电线, 针式, 10K Ω AHA, EKG CABLE, DIN, 10K Ω		
	EK-012	美标, 一体心电线, 香蕉插式, 10K Ω AHA, EKG CABLE, BANANA, 10K Ω		
	EK-013	欧标, 一体心电线, 扣式, 10K Ω IEC, EKG CABLE, SNAP, 10K Ω		
	EK-014	欧标, 一体心电线, 夹式, 10K Ω IEC, EKG CABLE, CLIP, 10K Ω		
	EK-015	欧标, 一体心电线, 针式, 10K Ω IEC, EKG CABLE, DIN, 10K Ω		
	EK-016	欧标, 一体心电线, 香蕉插式, 10K Ω IEC, EKG CABLE, BANANA, 10K Ω		
福田KUDA DENSHI	EK-017	美标, 一体心电线, 扣式, 4.7K Ω AHA, EKG CABLE, SNAP, 4.7K Ω	Fukuda Denshi: FX- 2111, FX-4010, FCP- 2155	
	EK-018	美标, 一体心电线, 夹式, 4.7K Ω AHA, EKG CABLE, CLIP, 4.7K Ω		
	EK-019	美标, 一体心电线, 针式, 4.7K Ω AHA, EKG CABLE, DIN, 4.7K Ω		
	EK-020	美标, 一体心电线, 香蕉插式, 4.7K Ω AHA, EKG CABLE, BANANA, 4.7K Ω		



本公司所有网站, 彩页所涉及到的图片, 文件, 商标, 版权均属于原作者, 本处出于产品说明需要而引用, 绝无它用

公司官方网站 : <http://www.touch-sz.com>



# 一体式心电图仪心电电缆和导联线

## One-Piece Series EKG Cable With Leads

兼容品牌 Manufacturer	产品编号 P/N	产品描述 Product description	兼容型号 Compatibility	仪器端插头 Interface
福田KUDA DENSHI	EK-021	欧标, 一体心电线, 扣式, 4.7K $\Omega$ IEC, EKG CABLE, SNAP, 4.7K $\Omega$	Fukuda Denshi:FX-2111, FX-4010, FCP-2155	
	EK-022	欧标, 一体心电线, 夹式, 4.7K $\Omega$ IEC, EKG CABLE, CLIP, 4.7K $\Omega$		
	EK-023	欧标, 一体心电线, 针式, 4.7K $\Omega$ IEC, EKG CABLE, DIN, 4.7K $\Omega$		
	EK-024	欧标, 一体心电线, 香蕉插式, 4.7K $\Omega$ IEC, EKG CABLE, BANANA, 4.7K $\Omega$		
铃谦 KANZ PC-104 CARDIOLINE REMCO	EK-025	美标, 一体心电线, 扣式, 4.7K $\Omega$ AHA, EKG CABLE, SNAP, 4.7K $\Omega$	KENZ:103, 106 Cardioline/remco:delta1, 3, 30, 60, delta1 plus, delta3 plus, delta60 plus	
	EK-026	美标, 一体心电线, 夹式, 4.7K $\Omega$ AHA, EKG CABLE, CLIP, 4.7K $\Omega$		
	EK-027	美标, 一体心电线, 针式, 4.7K $\Omega$ AHA, EKG CABLE, DIN, 4.7K $\Omega$		
	EK-028	美标, 一体心电线, 香蕉插式, 4.7K $\Omega$ AHA, EKG CABLE, BANANA, 4.7K $\Omega$		
	EK-029	欧标, 一体心电线, 扣式, 4.7K $\Omega$ IEC, EKG CABLE, SNAP, 4.7K $\Omega$		
	EK-030	欧标, 一体心电线, 夹式, 4.7K $\Omega$ IEC, EKG CABLE, CLIP, 4.7K $\Omega$		
	EK-031	欧标, 一体心电线, 针式, 4.7K $\Omega$ IEC, EKG CABLE, DIN, 4.7K $\Omega$		
	EK-032	欧标, 一体心电线, 香蕉插式, 4.7K $\Omega$ IEC, EKG CABLE, BANANA, 4.7K $\Omega$		
铃谦 KANZ PC-104 CARDIOLINE REMCO	EK-033	美标, 一体心电线, 扣式 AHA, EKG CABLE, SNAP	KENZ:103, 106 Cardioline/remco:delta1, 3, 30, 60, delta1 plus, delta3 plus, delta60 plus	
	EK-034	美标, 一体心电线, 夹式 AHA, EKG CABLE, CLIP		
	EK-035	美标, 一体心电线, 针式 AHA, EKG CABLE, DIN		
	EK-036	美标, 一体心电线, 香蕉插式 AHA, EKG CABLE, BANANA		
	EK-037	欧标, 一体心电线, 扣式 IEC, EKG CABLE, SNAP		
	EK-038	欧标, 一体心电线, 夹式 IEC, EKG CABLE, CLIP		
	EK-039	欧标, 一体心电线, 针式 IEC, EKG CABLE, DIN		
	EK-040	欧标, 一体心电线, 香蕉插式 IEC, EKG CABLE, BANANA		



本公司所有网站, 彩页所涉及到的图片, 文件, 商标, 版权均属于原作者, 本处出于产品说明需要而引用, 绝无它用

公司官方网站 : <http://www.touch-sz.com>

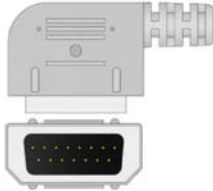
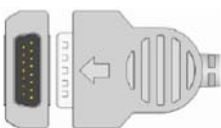

# 一体式心电图仪心电电缆和导联线

## One-Piece Series EKG Cable With Leads

兼容品牌 Manufacturer	产品编号 P/N	产品描述 Product description	兼容型号 Compatibility	仪器端插头 Interface
铃谦 KANZ PC-109	EK-041	美标, 一体心电线, 扣式 AHA, EKG CABLE, SNAP	KENZ ECG:108/110/1203/1205	
	EK-042	美标, 一体心电线, 夹式 AHA, EKG CABLE, CLIP		
	EK-043	美标, 一体心电线, 针式 AHA, EKG CABLE, DIN		
	EK-044	美标, 一体心电线, 香蕉插式 AHA, EKG CABLE, BANANA		
	EK-045	欧标, 一体心电线, 扣式 IEC, EKG CABLE, SNAP		
	EK-046	欧标, 一体心电线, 夹式 IEC, EKG CABLE, CLIP		
	EK-047	欧标, 一体心电线, 针式 IEC, EKG CABLE, DIN		
	EK-048	欧标, 一体心电线, 香蕉插式 IEC, EKG CABLE, BANANA		
马葵 GE-Medical	EK-049	美标, 一体心电线, 扣式, 10K Ω AHA, EKG CABLE, SNAP, 10K Ω	Hellige:MicroSmarm, MAC 500/1100, MAC 1200/1200 ST	
	EK-050	美标, 一体心电线, 夹式, 10K Ω AHA, EKG CABLE, CLIP, 10K Ω		
	EK-051	美标, 一体心电线, 针式, 10K Ω AHA, EKG CABLE, DIN, 10K Ω		
	EK-052	美标, 一体心电线, 香蕉插式, 10K Ω AHA, EKG CABLE, BANANA, 10K Ω		
	EK-053	欧标, 一体心电线, 扣式, 10K Ω IEC, EKG CABLE, SNAP, 10K Ω		
	EK-054	欧标, 一体心电线, 夹式, 10K Ω IEC, EKG CABLE, CLIP, 10K Ω		
	EK-055	欧标, 一体心电线, 针式, 10K Ω IEC, EKG CABLE, DIN, 10K Ω		
	EK-056	欧标, 一体心电线, 香蕉插式, 10K Ω IEC, EKG CABLE, BANANA, 10K Ω		
美敦力 MEDTRONIC PHYSIO CONTRO	EK-057	美标, 一体心电线, 扣式, 10K Ω AHA, EKG CABLE, SNAP, 10K Ω	MEDTRONIC PHYSIO CONTROL:Lifepal 12	
	EK-058	美标, 一体心电线, 夹式, 10K Ω AHA, EKG CABLE, CLIP, 10K Ω		
	EK-059	美标, 一体心电线, 针式, 10K Ω AHA, EKG CABLE, DIN, 10K Ω		
	EK-060	美标, 一体心电线, 香蕉插式, 10K Ω AHA, EKG CABLE, BANANA, 10K Ω		



本公司所有网站, 彩页所涉及到的图片, 文件, 商标, 版权均属于原作者, 本处出于产品说明需要而引用, 绝无它用

公司官方网站 : <http://www.touch-sz.com>



# 一体式心电图仪心电电缆和导联线

## One-Piece Series EKG Cable With Leads

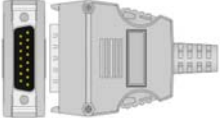
兼容品牌 Manufacturer	产品编号 P/N	产品描述 Product description	兼容型号 Compatibility	仪器端插头 Interface
美敦力 MEDTRONIC PHYSIO CONTRO	EK-061	欧标, 一体心电线, 扣式, 10K Ω IEC, EKG CABLE, SNAP, 10K Ω	MEDTRONIC PHYSIO CONTROL:Lifepal 12	
	EK-062	欧标, 一体心电线, 夹式, 10K Ω IEC, EKG CABLE, CLIP, 10K Ω		
	EK-063	欧标, 一体心电线, 针式, 10K Ω IEC, EKG CABLE, DIN, 10K Ω		
	EK-064	欧标, 一体心电线, 香蕉插式, 10K Ω IEC, EKG CABLE, BANANA, 10K Ω		
迈瑞 MINDRAY	EK-065	美标, 一体心电线, 扣式, 10K Ω AHA, EKG CABLE, SNAP, 10K Ω	12-Ld module	
	EK-066	美标, 一体心电线, 夹式, 10K Ω AHA, EKG CABLE, CLIP, 10K Ω		
	EK-067	美标, 一体心电线, 针式, 10K Ω AHA, EKG CABLE, DIN, 10K Ω		
	EK-068	美标, 一体心电线, 香蕉插式, 10K Ω AHA, EKG CABLE, BANANA, 10K Ω		
	EK-069	欧标, 一体心电线, 扣式, 10K Ω IEC, EKG CABLE, SNAP, 10K Ω		
	EK-070	欧标, 一体心电线, 夹式, 10K Ω IEC, EKG CABLE, CLIP, 10K Ω		
	EK-071	欧标, 一体心电线, 针式, 10K Ω IEC, EKG CABLE, DIN, 10K Ω		
	EK-072	欧标, 一体心电线, 香蕉插式, 10K Ω IEC, EKG CABLE, BANANA, 10K Ω		
摩托罗拉 MORTARA	EK-073	美标, 一体心电线, 扣式, 4.7K Ω AHA, EKG CABLE, SNAP, 4.7K Ω	MORTARA INSTRUMENT:ELI50/EL I100/ELI200	
	EK-074	美标, 一体心电线, 夹式, 4.7K Ω AHA, EKG CABLE, CLIP, 4.7K Ω		
	EK-075	美标, 一体心电线, 针式, 4.7K Ω AHA, EKG CABLE, DIN, 4.7K Ω		
	EK-076	美标, 一体心电线, 香蕉插式, 4.7K Ω AHA, EKG CABLE, BANANA, 4.7K Ω		
	EK-077	欧标, 一体心电线, 扣式, 4.7K Ω IEC, EKG CABLE, SNAP, 4.7K Ω		
	EK-078	欧标, 一体心电线, 夹式, 4.7K Ω IEC, EKG CABLE, CLIP, 4.7K Ω		
	EK-079	欧标, 一体心电线, 针式, 4.7K Ω IEC, EKG CABLE, DIN, 4.7K Ω		
	EK-080	欧标, 一体心电线, 香蕉插式, 4.7K Ω IEC, EKG CABLE, BANANA, 4.7K Ω		

本公司所有网站, 彩页所涉及到的图片, 文件, 商标, 版权均属于原作者, 本处出于产品说明需要而引用, 绝无它用

公司官方网站 : <http://www.touch-sz.com>



# 一体式心电图仪心电电缆和导联线

## One-Piece Series EKG Cable With Leads

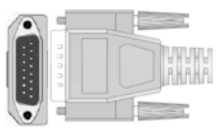
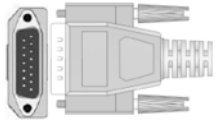
兼容品牌 Manufacturer	产品编号 P/N	产品描述 Product description	兼容型号 Compatibility	仪器端插头 Interface
NEC	EK-081	美标, 一体心电线, 扣式, 10K Ω AHA, EKG CABLE, SNAP, 10K Ω	NEC:YY-1063	
	EK-082	美标, 一体心电线, 夹式, 10K Ω AHA, EKG CABLE, CLIP, 10K Ω		
	EK-083	美标, 一体心电线, 针式, 10K Ω AHA, EKG CABLE, DIN, 10K Ω		
	EK-084	美标, 一体心电线, 香蕉插式, 10K Ω AHA, EKG CABLE, BANANA, 10K Ω		
	EK-085	欧标, 一体心电线, 扣式, 10K Ω IEC, EKG CABLE, SNAP, 10K Ω		
	EK-086	欧标, 一体心电线, 夹式, 10K Ω IEC, EKG CABLE, CLIP, 10K Ω		
	EK-087	欧标, 一体心电线, 针式, 10K Ω IEC, EKG CABLE, DIN, 10K Ω		
	EK-088	欧标, 一体心电线, 香蕉插式, 10K Ω IEC, EKG CABLE, BANANA, 10K Ω		
日本光电 NIHON KONDEN	EK-089	美标, 一体心电线, 扣式, 4.7K Ω AHA, EKG CABLE, SNAP, 4.7K Ω	Nihon Kohden:Cardiofax615 1/6353, Cardiofax EKG- 8270/8350/8370/8420 /8423/8450/8453/882 0/8823/8830/9130 Cardiofax-Q	
	EK-090	美标, 一体心电线, 夹式, 4.7K Ω AHA, EKG CABLE, CLIP, 4.7K Ω		
	EK-091	美标, 一体心电线, 针式, 4.7K Ω AHA, EKG CABLE, DIN, 4.7K Ω		
	EK-092	美标, 一体心电线, 香蕉插式, 4.7K Ω AHA, EKG CABLE, BANANA, 4.7K Ω		
	EK-093	欧标, 一体心电线, 扣式, 4.7K Ω IEC, EKG CABLE, SNAP, 4.7K Ω		
	EK-094	欧标, 一体心电线, 夹式, 4.7K Ω IEC, EKG CABLE, CLIP, 4.7K Ω		
	EK-095	欧标, 一体心电线, 针式, 4.7K Ω IEC, EKG CABLE, DIN, 4.7K Ω		
	EK-096	欧标, 一体心电线, 香蕉插式, 4.7K Ω IEC, EKG CABLE, BANANA, 4.7K Ω		
日本光电 NIHON KONDEN	EK-097	美标, 一体心电线, 扣式 AHA, EKG CABLE, SNAP	Cardiofax Q ECG- 9110K Cardiofax Q ECG- 9130K special screw, imperial standard (SAE)	
	EK-098	美标, 一体心电线, 夹式 AHA, EKG CABLE, CLIP		
	EK-099	美标, 一体心电线, 针式 AHA, EKG CABLE, DIN		
	EK-100	美标, 一体心电线, 香蕉插式 AHA, EKG CABLE, BANANA		

本公司所有网站, 彩页所涉及到的图片, 文件, 商标, 版权均属于原作者, 本处出于产品说明需要而引用, 绝无它用

公司官方网站 : <http://www.touch-sz.com>



# 一体式心电图仪心电电缆和导联线

## One-Piece Series EKG Cable With Leads

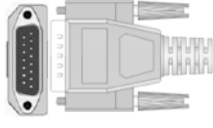
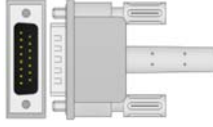
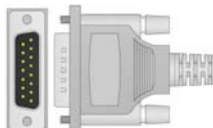
兼容品牌 Manufacturer	产品编号 P/N	产品描述 Product description	兼容型号 Compatibility	仪器端插头 Interface
日本光电 NIHON KONDEN	EK-101	欧标, 一体心电线, 扣式 IEC, EKG CABLE, SNAP	Cardiofax Q ECG-9110K Cardiofax Q ECG-9130K special screw, imperial standard (SAE)	
	EK-102	欧标, 一体心电线, 夹式 IEC, EKG CABLE, CLIP		
	EK-103	欧标, 一体心电线, 针式 IEC, EKG CABLE, DIN		
	EK-104	欧标, 一体心电线, 香蕉插式 IEC, EKG CABLE, BANANA		
飞利浦 PHILIPS/HP	EK-105	美标, 一体心电线, 扣式, 20K Ω AHA, EKG CABLE, SNAP, 20K Ω	M1770A PageWriter 200i, M1771A PageWriter 200, M1772A PageWriter 100,	
	EK-106	美标, 一体心电线, 夹式, 20K Ω AHA, EKG CABLE, CLIP, 20K Ω		
	EK-107	美标, 一体心电线, 针式, 20K Ω AHA, EKG CABLE, DIN, 20K Ω		
	EK-108	美标, 一体心电线, 香蕉插式, 20K Ω AHA, EKG CABLE, BANANA, 20K Ω		
	EK-109	欧标, 一体心电线, 扣式, 20K Ω IEC, EKG CABLE, SNAP, 20K Ω		
	EK-110	欧标, 一体心电线, 夹式, 20K Ω IEC, EKG CABLE, CLIP, 20K Ω		
	EK-111	欧标, 一体心电线, 针式, 20K Ω IEC, EKG CABLE, DIN, 20K Ω		
	EK-112	欧标, 一体心电线, 香蕉插式, 20K Ω IEC, EKG CABLE, BANANA, 20K Ω		
AVIONICS (DEI MAR) CUSTO-MED DEL MAR ERGO LINE ESAOTE BIOMED FIDELITY INNOMED KONTRON REYNOLDS 席勒 SCHILLER TRENTINA (ELL ETTRONICA) VONBERG BIONET	EK-113	美标, 一体心电线, 扣式, 10K Ω AHA, EKG CABLE, SNAP, 10K Ω	Avionics (Del Mar): 910/920/930/940/950/960/970/980 Custo-med: Custo-norm Del mar: 910920, 930, 940, 942, 950, 960, 970, 980 Ergoline: Autoruler, Autoscript 6/12 Cardiette, EK 3003/3012, Ergoline Esaote Biomedica: EKG P120 Fidelity: LP 3000 Innomed: Heart Mirror (3-Kanal)	
	EK-114	美标, 一体心电线, 夹式, 10K Ω AHA, EKG CABLE, CLIP, 10K Ω		
	EK-115	美标, 一体心电线, 针式, 10K Ω AHA, EKG CABLE, DIN, 10K Ω		
	EK-116	美标, 一体心电线, 香蕉插式, 10K Ω AHA, EKG CABLE, BANANA, 10K Ω		
	EK-117	欧标, 一体心电线, 扣式, 10K Ω IEC, EKG CABLE, SNAP, 10K Ω		
	EK-118	欧标, 一体心电线, 夹式, 10K Ω IEC, EKG CABLE, CLIP, 10K Ω		
	EK-119	欧标, 一体心电线, 针式, 10K Ω IEC, EKG CABLE, DIN, 10K Ω		
	EK-120	欧标, 一体心电线, 香蕉插式, 10K Ω IEC, EKG CABLE, BANANA, 10K Ω		

本公司所有网站, 彩页所涉及到的图片, 文件, 商标, 版权均属于原作者, 本处出于产品说明需要而引用, 绝无它用

公司官方网站 : <http://www.touch-sz.com>





# 一体式心电图仪心电电缆和导联线

## One-Piece Series EKG Cable With Leads

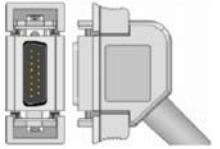
兼容品牌 Manufacturer	产品编号 P/N	产品描述 Product description	兼容型号 Compatibility	仪器端插头 Interface
AVIONICS (DEI MAR) CUSTO-MED DEL MAR ERGOLINE ESAOTE BIOMED FIDELITY INNOMED KONTRON REYNOLDS 席勒 SCHILLER TRENTINA (ELL ETRONICA) VONBERG BIONET	EK-121	美标, 一体心电线, 扣式 AHA, EKG CABLE, SNAP	Kontron:EKG P80 Reynolds:Cardiotrac k 12 Schiller:AT3, AT5, AT 6, AT10, AT104 PC, AT104, CS6, CS12, C S100, CS200, Trentina :AllExcel-Types Von Berg:Bioset 9000, Hellige:EK 51	
	EK-122	美标, 一体心电线, 夹式 AHA, EKG CABLE, CLIP		
	EK-123	美标, 一体心电线, 针式 AHA, EKG CABLE, DIN		
	EK-124	美标, 一体心电线, 香蕉插式 AHA, EKG CABLE, BANANA		
	EK-125	欧标, 一体心电线, 扣式 IEC, EKG CABLE, SNAP		
	EK-126	欧标, 一体心电线, 夹式 IEC, EKG CABLE, CLIP		
	EK-127	欧标, 一体心电线, 针式 IEC, EKG CABLE, DIN		
	EK-128	欧标, 一体心电线, 香蕉插式 IEC, EKG CABLE, BANANA		
西门子 SIEMENS 海力格 HELLIGE 博世 BOSCH CAMBRIDGE CUSTO-MED DEGO VON BERG HORMANN	EK-129	美标, 一体心电线, 扣式 AHA, EKG CABLE, SNAP	Siemens:Cardiostat1 /3t/703/710, Cardina C, Cardirex3T/4/6T/6 2, Cathcor, MegacardE lemaA/B, R, R/E, Mingo doc, Mingocard3/4/7, Mingograph4/62/81/8 2/740. Mingolog7, Mir acard1, Sirecard803, Sirecust7, Hellige:EK36, EK41, E K43, EK53, EK56, EK403 , EK413, EK512, EK512E , EK512P, Cardiosmark , CardioSys, Coma Bosch:603D, 603ER, 60 3S, 606 Cambridge"CM6000, CM 6400 Custo-med:Custo- card DEGO:Cardiomed 3	
	EK-130	美标, 一体心电线, 夹式 AHA, EKG CABLE, CLIP		
	EK-131	美标, 一体心电线, 针式 AHA, EKG CABLE, DIN		
	EK-132	美标, 一体心电线, 香蕉插式 AHA, EKG CABLE, BANANA		
	EK-133	欧标, 一体心电线, 扣式 IEC, EKG CABLE, SNAP		
	EK-134	欧标, 一体心电线, 夹式 IEC, EKG CABLE, CLIP		
	EK-135	欧标, 一体心电线, 针式 IEC, EKG CABLE, DIN		
	EK-136	欧标, 一体心电线, 香蕉插式 IEC, EKG CABLE, BANANA		
	EK-137	美标, 一体心电线, 扣式, 4.7K Ω AHA, EKG CABLE, SNAP, 4.7K Ω		
	EK-138	美标, 一体心电线, 夹式, 4.7K Ω AHA, EKG CABLE, CLIP, 4.7K Ω		
	EK-139	美标, 一体心电线, 针式, 4.7K Ω AHA, EKG CABLE, DIN, 4.7K Ω		
EK-140	美标, 一体心电线, 香蕉插式, 4.7K Ω AHA, EKG CABLE, BANANA, 4.7K Ω			



本公司所有网站, 彩页所涉及到的图片, 文件, 商标, 版权均属于原作者, 本处出于产品说明需要而引用, 绝无它用

公司官方网站 : <http://www.touch-sz.com>

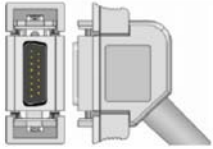

# 一体式心电图仪心电电缆和导联线

## One-Piece Series EKG Cable With Leads

兼容品牌 Manufacturer	产品编号 P/N	产品描述 Product description	兼容型号 Compatibility	仪器端插头 Interface
	EK-141	欧标, 一体心电线, 扣式, 4.7K $\Omega$ IEC, EKG CABLE, SNAP, 4.7K $\Omega$		
	EK-142	欧标, 一体心电线, 夹式, 4.7K $\Omega$ IEC, EKG CABLE, CLIP, 4.7K $\Omega$		
	EK-143	欧标, 一体心电线, 针式, 4.7K $\Omega$ IEC, EKG CABLE, DIN, 4.7K $\Omega$		
	EK-144	欧标, 一体心电线, 香蕉插式, 4.7K $\Omega$ IEC, EKG CABLE, BANANA, 4.7K $\Omega$		
太空 PACELABS	EK-145	美标, 一体心电线, 扣式, 1K $\Omega$ AHA, EKG CABLE, SNAP, 1K $\Omega$	Spacelabs:90496 Ultraview Module	
	EK-146	美标, 一体心电线, 夹式, 1K $\Omega$ AHA, EKG CABLE, CLIP, 1K $\Omega$		
	EK-147	美标, 一体心电线, 针式, 1K $\Omega$ AHA, EKG CABLE, DIN, 1K $\Omega$		
	EK-148	美标, 一体心电线, 香蕉插式, 1K $\Omega$ AHA, EKG CABLE, BANANA, 1K $\Omega$		
	EK-149	欧标, 一体心电线, 扣式, 1K $\Omega$ IEC, EKG CABLE, SNAP, 1K $\Omega$		
	EK-150	欧标, 一体心电线, 夹式, 1K $\Omega$ IEC, EKG CABLE, CLIP, 1K $\Omega$		
	EK-151	欧标, 一体心电线, 针式, 1K $\Omega$ IEC, EKG CABLE, DIN, 1K $\Omega$		
	EK-152	欧标, 一体心电线, 香蕉插式, 1K $\Omega$ IEC, EKG CABLE, BANANA, 1K $\Omega$		
中联健益 ZHONLIANJIAN YI 上海光电 SHANGHAIKOND EN	EK-153	美标, 一体心电线, 扣式 AHA, EKG CABLE, SNAP	ShangHai Kohden: ECG- 6511, 6151, 6551, 8110 P/K, 6403, 65046353 JIANYI: XD-106, XD- 104B/D	
	EK-154	美标, 一体心电线, 夹式 AHA, EKG CABLE, CLIP		
	EK-155	美标, 一体心电线, 针式 AHA, EKG CABLE, DIN		
	EK-156	美标, 一体心电线, 香蕉插式 AHA, EKG CABLE, BANANA		
	EK-157	欧标, 一体心电线, 扣式 IEC, EKG CABLE, SNAP		
	EK-158	欧标, 一体心电线, 夹式 IEC, EKG CABLE, CLIP		
	EK-159	欧标, 一体心电线, 针式 IEC, EKG CABLE, DIN		
	EK-160	欧标, 一体心电线, 香蕉插式 IEC, EKG CABLE, BANANA		

本公司所有网站, 彩页所涉及到的图片, 文件, 商标, 版权均属于原作者, 本处出于产品说明需要而引用, 绝无它用

公司官方网站 : <http://www.touch-sz.com>



# 分体式心电图仪电缆与导联线 EKG Trunk Cable With Leadwires

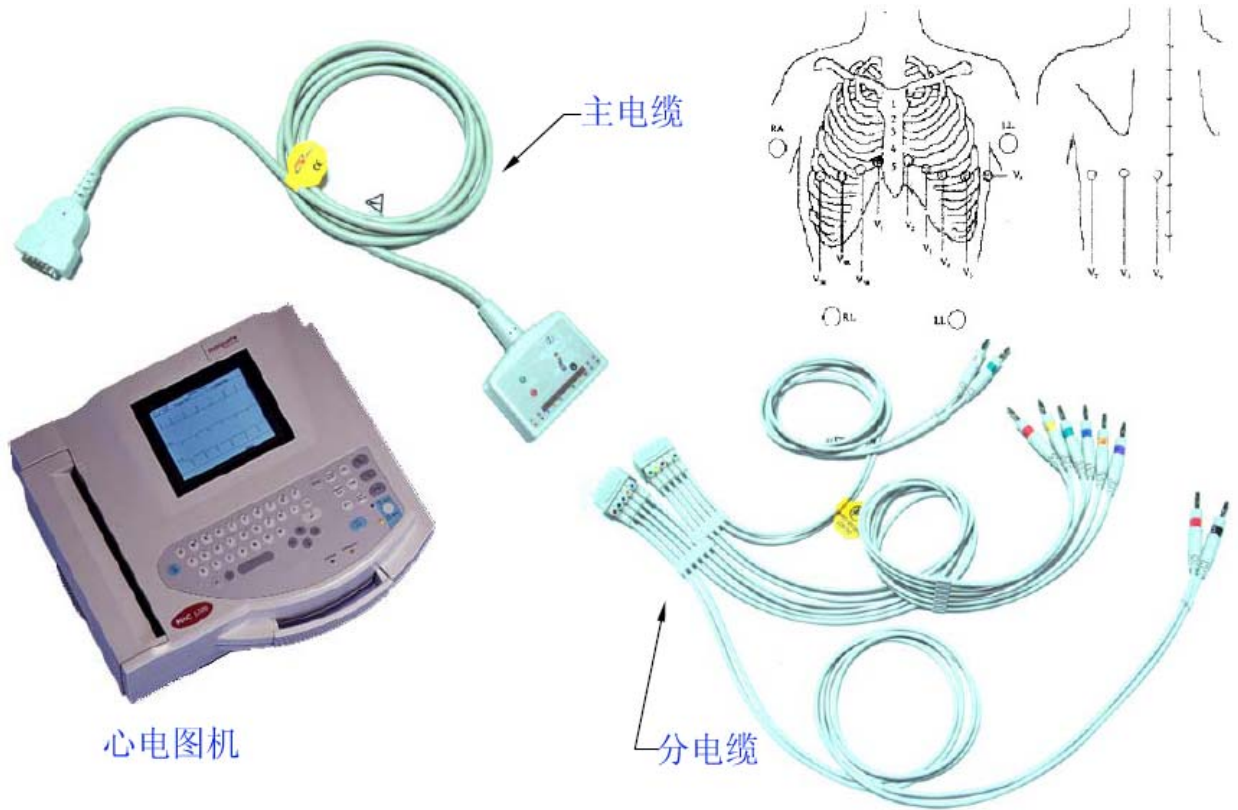

仪器端连接器

病人端连接器

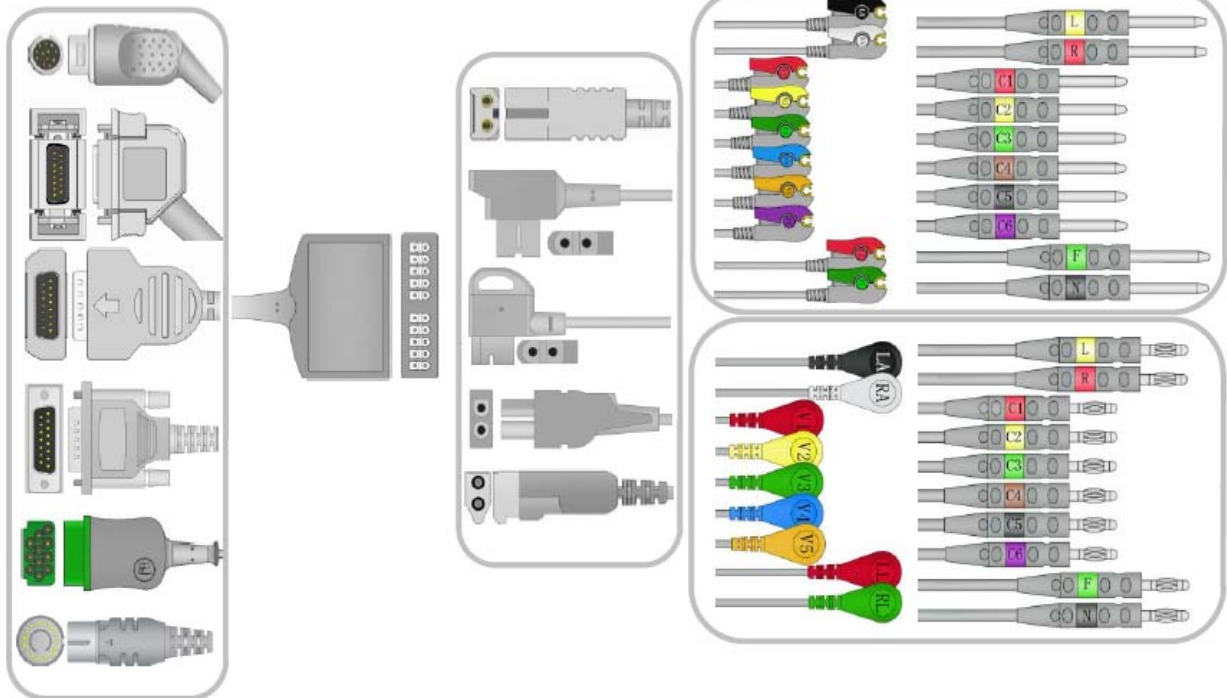

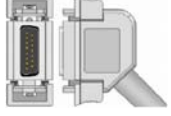

## 分体式心电图仪电缆与导联线 EKG Trunk Cable With Leadwires

兼容品牌 Manufacturer	产品编号 P/N	产品描述 Product description	兼容仪器型号 Compatibility	仪器端插头 Interface	
马葵 MARQUETTE 海力格 HELLGE	ET-001	MAC1200十导心电电缆, DB15M & VS型十导分线器, L=2.2米, 10K $\Omega$ 电阻, (AHA/IEC)	马葵:MAC1200/1200ST		
GE-Medical	ET-002	马葵十导心电电缆, 方形11针插头 & VS型分线器, L=2.2米, 1K $\Omega$ 电阻, (AHA/IEC)	For GE Eagle, Solar, Dash, Tram, MAC-Lab Cab System		
迈瑞 MINDRAY	ET-003	十导心电电缆, 圆形12针插头 & VS型分线器, L=2.2米, 1K $\Omega$ 电阻, (AHA/IEC)	PM7000/PM9000Super/PM9000 Express		
席勒 ESAOTE BIOMED INNOMED FIDELITY KONTRON REYNOLDS TRENTINA ELLETTRONICA VON BERG	ET-004	十导心电电缆, DB-15M & VS十导分线器, L=2.2m, 10K $\Omega$ 电阻, (AHA/IEC)	席勒:AT1, AT2, AT3, AT4, AT5, AT6, AT10, AT60, AT101, AT102, AT104A, T104PC, CS100, CS6, CS6/12		
	ET-005	十导心电电缆, DB-15M & VS十导分线器, L=2.2m, (AHA/IEC)	Esaote biomed:EKG P80, 120 Innomed:Heart MIRROR (3-kANAL)		
西门子 BOSCH CAMBRIDGE CUSTO-MED DEGO HELLIGE SIEMENS	ET-006	十导心电电缆, DB-15M & VS十导分线器, L=2.2m, 4.7K $\Omega$ 电阻	Bosch:603D, 603ER, 603S, 606 Cambridge:CM6000, CM6400 Customed:Custo-card DEGO:Cardiomed 3		
太空 SPACELABS	ET-007	十导心电电缆, 圆形17针插头 & VSVS型分线器, L=2.2m, 1K $\Omega$ 电阻, (AHA/IEC)			







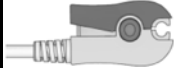

本公司所有网站, 彩页所涉及到的图片, 文件, 商标, 版权均属于原作者, 本处出于产品说明需要而引用, 绝无它用

公司官方网站 :<http://www.touch-sz.com>



# 分体式监护心电电缆和导联线

## Two-Piece Series Patient Cable With Leads

兼容品牌 Manufacturer	产品编号 P/N	产品描述 Product description	兼容仪器型号 Compatibility	仪器端插头 Interface
马葵 GE-MARQUETTE 海力格 HELLIGE	ET-008	十导联分线, 扣式, AHA/IEC	VS型十导联 四肢导联线长130cm, 胸吸气导联线长70cm, 无电阻, 插头为:VS- 2P	
	ET-009	十导联分线, 夹式, AHA/IEC		
	ET-010	十导联分线, DIN式3.0mm插针, AHA/IEC		
	ET-011	十导联分线, 4.0mm插针, AHA/IEC		
马葵 GE-MARQUETTE	ET-012	十导联分线, 扣式, AHA/IEC	MAX十导联 四肢导联线长130cm, 胸吸气导联线长70cm, 无电阻, 插头为:L型2 孔插头	
	ET-013	十导联分线, 夹式, AHA/IEC		
	ET-014	十导联分线, DIN式3.0mm插针, AHA/IEC		
	ET-015	十导联分线, 4.0mm插针, AHA/IEC		
福田 FUKUDA	ET-016	十导联分线, 扣式, AHA/IEC	欧式五导联线长102cm	
	ET-017	十导联分线, 夹式, AHA/IEC		









本公司所有网站, 彩页所涉及到的图片, 文件, 商标, 版权均属于原作者, 本处出于产品说明需要而引用, 绝无它用

公司官方网站 : <http://www.touch-sz.com>

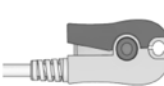

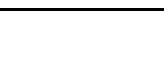
# 分体式监护心电电缆和导联线

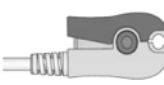
## Two-Piece Series Patient Cable With Leads

康美 CONMED JINJIANG	ET-018	十导联分线, 扣式, AHA/IEC	康美十导联 四肢导联线长130cm, 胸吸气导联线长70cm,		
	ET-019	十导联分线, 夹式, AHA/IEC			
	ET-020	十导联分线, DIN式3.0mm插针, AHA/IEC			
	ET-021	十导联分线, 4.0mm插针, AHA/IEC			
飞利浦 PHILIPS	ET-022	十导联分线, 扣式, AHA/IEC	Trim十导联线, 四肢导 联线长39~99cm, 胸吸 气导联线长 24~61cm, Use with Philips Instrument M1700A M1701A M1702A, TRIM II, Trim 1, 2, 3		
	ET-023	十导联分线, 夹式, AHA/IEC			
	ET-024	十导联分线, DIN式3.0mm插针, AHA/IEC			
	ET-025	十导联分线, 4.0mm插针, AHA/IEC			



# 分体式心电图仪电缆与导联线

## EKG Trunk Cable With Leadwires

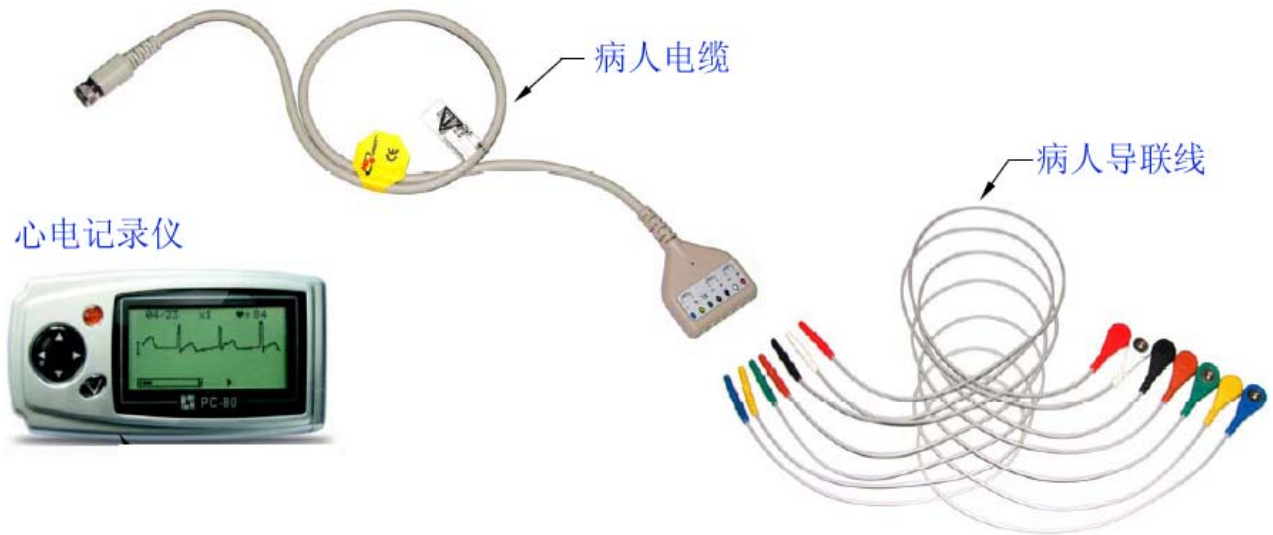

仪器端插头

分线器类型

导联线插头



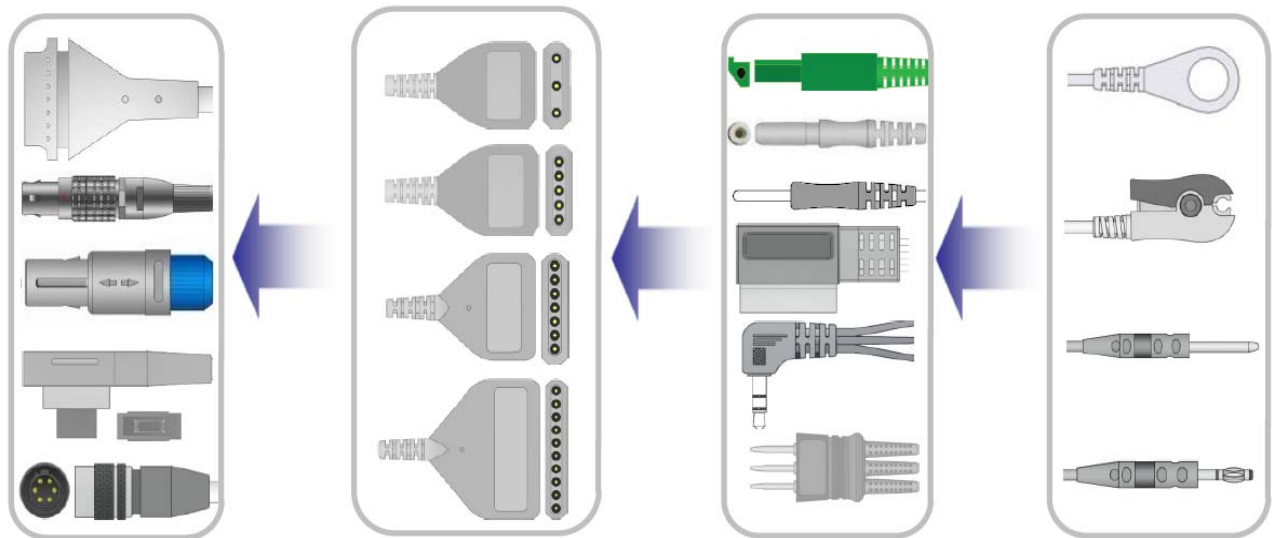











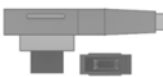



病人端电极





# 动态心电电缆与导联线

## Holter Recorder ECG Patient Cable and leads

兼容品牌 Manufacturer	产品编号 P/N	产品描述 Product description	兼容仪器型号 Compatibility	仪器端插头 Interface	
伯迪克 BURDICK	HE-001	DIN式五导联心电电缆, L:80cm, 2.54x7PIN & DIN式五导联分线器, (AHA)	92512 holther		
	HE-002	DIN式七导联心电电缆, L:80cm, 2.54x7PIN & DIN式五导联分线器, (AHA)	92513 holther		
通用医疗 GE-Marputte Rozinn	HE-003	DIN式五导联心电电缆, L:80cm, 12PIN金手指 & DIN式五导联分线器, (AHA)	For GE SEER MC Holter Recorder		
	HE-004	DIN式七导联心电电缆, L:80cm, 12PIN金手指 & DIN式七导联分线器, (AHA)			
	HE-005	DIN式十导联心电电缆, L:80cm, 2.54x7PIN & DIN式十导联分线器, (AHA)			
马葵 GE-MARQUETTE ROZINN GETEMED	HE-006	锁式五导联心电电缆, L:45cm, 锁式7孔 & DIN式五导联分线器, (AHA)	For GE marqutre:8000, 8200, 8500, SEER Holter Recorder model:151		
	HE-007	DIN式七导联心电电缆, L:80cm, 2.54x7PIN & DIN式七导联分线器, (AHA)			
蓝港 LANDCOM	HE-008	DIN式七导联心电电缆, L:45cm, FGG. 1B 7PIN & DIN式七导联分线器, (AHA)			
	HE-009	DIN式十导联心电电缆, L:45cm, FGG. 0B 10PIN & DIN式十导联分线器, (AHA)			
博利渥 BRENTWOOD 博英	HE-010	DIN式七导联心电电缆, L:45cm, FGG. 0B 7PIN & DIN式七导联分线器, (AHA)	博利渥:BI9000 博利渥:BH-3000		

本公司所有网站, 彩页所涉及到的图片, 文件, 商标, 版权均属于原作者, 本处出于产品说明需要而引用, 绝无它用

公司官方网站 :<http://www.touch-sz.com>





# 动态心电电缆与导联线

## Holter Recorder ECG Patient Cable and leads















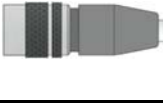

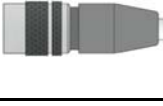

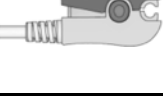

BIOMEDICAL INSTRUMENTS (BI)	HE-011	DIN式十导联心电电缆, L:45cm, FGG. 0B 10PIN & DIN式十导联分线器, (AHA)	博利渥: BH-1200 HOLTER8800		
康泰 CONTEC (CMS)	HE-012	DIN式七导联心电电缆, L:45cm, FGG. 1B 7PIN & DIN式七导联分线器, (AHA)	博利渥: BI9000 博利渥: BH-3000		
中科健仪 BIOX	HE-013	DIN式七导联心电电缆, L:45cm, 塑料 14PIN & DIN式七导联分线器, (AHA)	中科健仪: CB-2300-A, 博英: BI9000TL		
	HE-014	DIN式十导联心电电缆, L:45cm, 塑料 14PIN & DIN式十导联分线器, (AHA)	中科健仪: CB-1300-A		
牛津 MEDILOG	HE-015	DIN式七导联心电电缆, L:45cm, 塑料 14PIN & DIN式七导联分线器, (AHA)	Medilog: FD5		
日本光电 NIHON KOHDEN	HE-016	BR-546S一体三导联线, L:102cm, 插头: DIN2.0*3PIN, (IEC), 扣式			
	HE-017	BR-546S一体三导联线, L:102cm, 插头: DIN2.0*3PIN, (IEC), 夹式			
NEC	HE-018	YCF205一体三导联线, L:76cm, (IEC), 扣式			
	HE-019	YCF205一体三导联线, L:76cm, (IEC), 夹式			
	HE-020	47502一体三导联线, L:76cm, (IEC), 扣式			
	HE-021	47502一体三导联线, L:76cm, (IEC), 夹式			

本公司所有网站, 彩页所涉及到的图片, 文件, 商标, 版权均属于原作者, 本处出于产品说明需要而引用, 绝无它用  
公司官方网站 : <http://www.touch-sz.com>

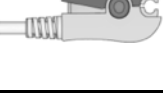

# 动态心电电缆与导联线

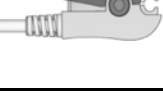
## Holter Recorder ECG Patient Cable and leads

飞利浦 PHILIPS	HE-022	遥测心电五导联线, L:102cm, 美标 (IEC), 扣式		
	HE-023	遥测心电五导联线, L:102cm, 美标 (AHA), 夹式		
PI	HE-024	一体式六导联线, L:102cm, 插头:HRS-4P, (IEC), 扣式		
	HE-025	一体式四导联线, L:102cm, 插头:HRS-4P, (IEC), 夹式		
博英	HE-026	一体式七导联线, L:45cm, 插头:塑料 14PIN, (AHA), 扣式		
超恩 TELEMETRY MONITORING SYSTEM MMED600R D-300E	HE-027	一体式三导联线, L:102cm, 插头:单定位5针塑料插头 (IEC), 扣式		
	HE-028	一体式三导联线, L:102cm, 插头:单定位5针塑料插头 (IEC), 夹式		
科瑞康 PC-600 TELEMETRY MONITORING	HE-029	一体式三导联线, L:102cm, 插头:DIN2.0*3PIN, (IEC), 扣式		
	HE-030	一体式三导联线, L:102cm, 插头:DIN2.0*3PIN, (IEC), 夹式		
	HE-031	一体式三导联线, L:102cm, 插头:2.5立体声, (AHA), 扣式		
	HE-032	一体式三导联线, L:102cm, 插头:2.5立体声, (AHA), 夹式		







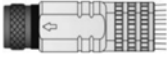

本公司所有网站, 彩页所涉及到的图片, 文件, 商标, 版权均属于原作者, 本处出于产品说明需要而引用, 绝无它用

公司官方网站 : <http://www.touch-sz.com>



# 动态心电电缆与导联线

## Holter Recorder ECG Patient Cable and leads

通用医疗 GE-Marputte Rozinn	HE-033	一体式三导联 线, L:102cm, (AHA), 扣式		
	HE-034	一体式三导联 线, L:102cm, (AHA), 夹式		
通用医疗 GE-SEER LIGHT	HE-035	SEER Light一体式五导联 线, (AHA), 扣式		
	HE-036	SEER Light一体式七导联 线, (AHA), 扣式		
摩托罗拉 MORTALA	HE-037	带状一体式十导联 线, (AHA/IEC), 扣式		
美高仪 ECGLAB TDA3.0	HE-038	一体式五导联 线, L:102cm, 2.5+3.5立体声插 头, (AHA), 扣式		
福田 FUKUDA	HE-039	一体式四导联, L:102cm, 插 头:6针插头头, (AHA), 夹式		
蓝港 LANDCOM STETHOSCOPE 美高仪 MGY-M1	HE-040	一体式五导联 线, L:102cm, 2.5+3.5立体声插 头, (AHA), 扣式		
	HE-041	一体式四导联, L:102cm, 插 头:6针插头头, (AHA), 夹式		
DIN式2.0导联 线 BIOMEDICAL SYSTEM:DH 073	HE-042	2.0DIN式七导联, L:0.61米 /1.02米, (AHA/IEC), 扣式		
	HE-043	2.0DIN式七导联, L:0.61米 /1.02米, (AHA/IEC), 夹式		

本公司所有网站, 彩页所涉及到的图片, 文件, 商标, 版权均属于原作者, 本处出于产品说明需要而引用, 绝无它用

公司官方网站 : <http://www.touch-sz.com>



# 动态心电电缆与导联线

## Holter Recorder ECG Patient Cable and leads

DIN式2.0导联线 ELA MEDICAL	HE-044	2.0DIN式三导联线, L:0.61米/1.02米, (AHA/IEC), 扣式			
	HE-045	2.0DIN式五导联线, L:0.61米/1.02米, (AHA/IEC), 扣式			
LL式1.5mm单孔导联线 牛津 MEDILOG:FD4	HE-046	1.5mmLL型三导联, L:45cm, (AHA/IEC), 扣式			
	HE-047	1.5mmLL型三导联, L:45cm, (AHA/IEC), 夹式			
	HE-048	1.5mmLL型五导联, L:45cm, (AHA/IEC), 扣式			
	HE-049	1.5mmLL型五导联, L:45cm, (AHA/IEC), 夹式			
	HE-050	1.5mmLL型三导联, L:61cm, (AHA/IEC), 扣式			
	HE-051	1.5mmLL型三导联, L:61cm, (AHA/IEC), 夹式			
	HE-052	1.5mmLL型五导联, L:61cm, (AHA/IEC), 扣式			
LL式1.5mm单孔导联线 牛津 MEDILOG:FD4	HE-053	1.5mmLL型五导联, L:61cm, (AHA/IEC), 夹式			
	HE-054	1.5mmLL型三导联, L:102cm, (AHA/IEC), 扣式			

本公司所有网站, 彩页所涉及到的图片, 文件, 商标, 版权均属于原作者, 本处出于产品说明需要而引用, 绝无它用

公司官方网站 :<http://www.touch-sz.com>



# 动态心电电缆与导联线

## Holter Recorder ECG Patient Cable and leads

LL式1.5mm单孔 导联线 牛津 MEDIALOG:FD4	HE-055	1.5mmLL型三导联, L:102cm, (AHA/IEC), 夹式			
	HE-056	1.5mmLL型五导联, L:102cm, (AHA/IEC), 扣式			
	HE-057	1.5mmLL型五导联, L:102cm, (AHA/IEC), 夹式			
	HE-058	1.5mmLL型七导联, L:45cm, (AHA/IEC), 扣式			
	HE-059	1.5mmLL型七导联, L:45cm, (AHA/IEC), 夹式			
	HE-060	1.5mmLL型七导联, L:61cm, (AHA/IEC), 扣式			
	HE-061	1.5mmLL型七导联, L:61cm, (AHA/IEC), 夹式			
	HE-062	1.5mmLL型七导联, L:102cm, (AHA/IEC), 扣式			
	HE-063	1.5mmLL型七导联, L:102cm, (AHA/IEC), 夹式			
1.5通关DIN式 导联线 (通用型)	HE-064	DIN式三导联线, L:45cm, (AHA/IEC), 扣式			
	HE-065	DIN式三导联线, L:45cm, (AHA/IEC), 夹式			

本公司所有网站, 彩页所涉及到的图片, 文件, 商标, 版权均属于原作者, 本处出于产品说明需要而引用, 绝无它用

公司官方网站 : <http://www.touch-sz.com>



# 动态心电电缆与导联线

## Holter Recorder ECG Patient Cable and leads

1.5 通关DIN式 导联线 (通用型)	HE-066	DIN式五导联线, L:45cm, (AHA/IEC), 扣式		
	HE-067	DIN式五导联线, L:45cm, (AHA/IEC), 夹式		
	HE-068	DIN式三导联线, L:61cm, (AHA/IEC), 扣式		
	HE-069	DIN式三导联线, L:61cm, (AHA/IEC), 夹式		
	HE-070	DIN式五导联线, L:61cm, (AHA/IEC), 扣式		
	HE-071	DIN式五导联线, L:61cm, (AHA/IEC), 夹式		
	HE-072	DIN式三导联线, L:102cm, (AHA/IEC), 扣式		
	HE-073	DIN式三导联线, L:102cm, (AHA/IEC), 夹式		
	HE-074	DIN式五导联线, L:102cm, (AHA/IEC), 扣式		
	HE-075	DIN式五导联线, L:102cm, (AHA/IEC), 夹式		
	HE-076	DIN式七导联线, L:102cm, (AHA/IEC), 扣式		

本公司所有网站, 彩页所涉及到的图片, 文件, 商标, 版权均属于原作者, 本处出于产品说明需要而引用, 绝无它用  
公司官方网站 : <http://www.touch-sz.com>



# 动态心电电缆与导联线

## Holter Recorder ECG Patient Cable and leads

1.5 通关DIN式 导联线 (通用型)	HE-077	DIN式七导联线, L:102cm, (AHA/IEC), 夹式			
	HE-078	DIN式十导联线, L:45cm, (AHA/IEC), 扣式			
	HE-079	DIN式十导联线, L:45cm, (AHA/IEC), 夹式			
	HE-080	DIN式十导联线, L:61cm, (AHA/IEC), 扣式			
	HE-081	DIN式十导联线, L:61cm, (AHA/IEC), 夹式			
	HE-082	DIN式十导联线, L:102cm, (AHA/IEC), 扣式			
	HE-083	DIN式十导联线, L:102cm, (AHA/IEC), 夹式			
康美 美高仪 美国世纪 3000	HE-084	DIN式七导联线, L:102cm, (AHA/IEC), 扣式			
	HE-085	DIN式七导联线, L:102cm, (AHA/IEC), 夹式			



# 有创血压传感器电缆

## Invasive Pressure Transducers cable

监护仪



有创血压电缆



有创血压传感器



仪器端接头

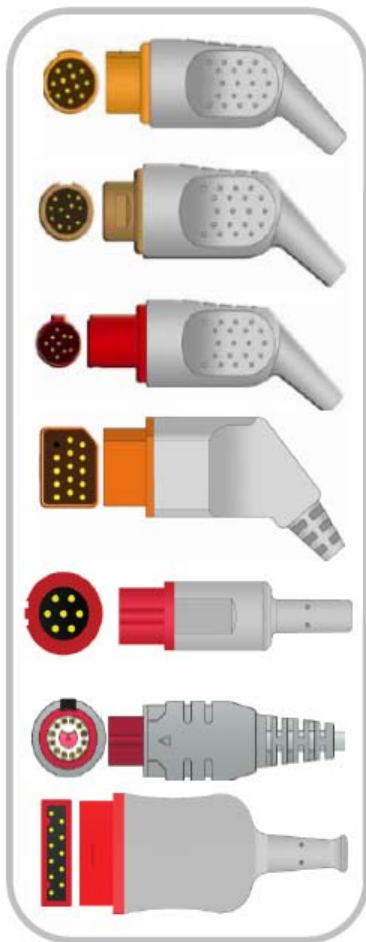

连接器

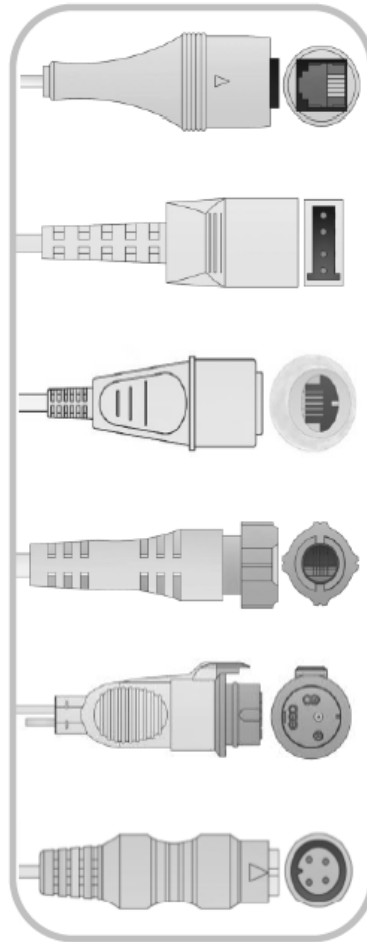

传感器插头







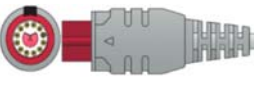

# 有创血压传感器电缆

## Invasive Pressure Transducers cable

兼容品牌 Manufacture	产品编号 P/N	产品描述 Product description	兼容型号 Compatibility	仪器端插头 Interface
德恩 DATEX	IP-001	适用雅培压力传感器电缆, L:12ft, 圆形10孔插头&6P6C母座		
	IP-002	适用尤它压力传感器电缆, L:12ft, 圆形10孔插头&4P母座		
	IP-003	适用爱德华压力传感器电缆, L:12ft, 圆形10孔插头&5P插座		
	IP-004	适用贝达压力传感器电缆, L:12ft, 圆形10孔插头&7孔插座		
	IP-005	适用飞利浦压力传感器电缆, L:12ft, 圆形10孔插头&4孔插座		
	IP-006	适用MAXXIM压力传感器电缆, L:12ft, 圆形10孔插头&5P插座		
福田 FUKUDA	IP-007	适用雅培压力传感器电缆, L:12ft, 圆形12针插头&6P6C母座		
	IP-008	适用尤它压力传感器电缆, L:12ft, 圆形12针插头&4P母座		
	IP-009	适用爱德华压力传感器电缆, L:12ft, 圆形12针插头&5P插座		
	IP-010	适用贝达压力传感器电缆, L:12ft, 圆形12针插头&7孔插座		
	IP-011	适用飞利浦压力传感器电缆, L:12ft, 圆形12针插头&4孔插座		
	IP-012	适用MAXXIM压力传感器电缆, L:12ft, 圆形12针插头&5P插座		
通用-马葵 GE-MARQUETTE	IP-013	适用雅培压力传感器电缆, L:12ft, 方形11针插头&6P6C母座		
	IP-014	适用尤它压力传感器电缆, L:12ft, 方形11针插头&4P母座		
	IP-015	适用爱德华压力传感器电缆, L:12ft, 方形11针插头&5P插座		

本公司所有网站, 彩页所涉及到的图片, 文件, 商标, 版权均属于原作者, 本处出于产品说明需要而引用, 绝无它用

公司官方网站 : <http://www.touch-sz.com>



# 有创血压传感器电缆

## Invasive Pressure Transducers cable

兼容品牌 Manufacture	产品编号 P/N	产品描述 Product description	兼容型号 Compatibility	仪器端插头 Interface
通用-马葵 GE-MARQUETTE	IP-016	适用贝达压力传感器电缆, L:12ft, 方形11针插头&7孔插座		
	IP-017	适用飞利浦压力传感器电缆, L:12ft, 方形11针插头&4孔插座		
	IP-018	适用MAXXIM压力传感器电缆, L:12ft, 方形11针插头&5P插座		
迈瑞 MINDRAY	IP-019	适用雅培压力传感器电缆, L:12ft, 方形11针插头&6P6C母座		
	IP-020	适用尤它压力传感器电缆, L:12ft, 方形11针插头&4P母座		
	IP-021	适用爱德华压力传感器电缆, L:12ft, 方形11针插头&5P插座		
	IP-022	适用贝达压力传感器电缆, L:12ft, 方形11针插头&7孔插座		
	IP-023	适用飞利浦压力传感器电缆, L:12ft, 方形11针插头&4孔插座		
	IP-024	适用MAXXIM压力传感器电缆, L:12ft, 方形11针插头&5P插座		
飞利浦 PHILIPS	IP-025	适用雅培压力传感器电缆, L:12ft, 圆形12针插头&6P6C母座		
	IP-026	适用尤它压力传感器电缆, L:12ft, 圆形12针插头&4P母座		
	IP-027	适用爱德华压力传感器电缆, L:12ft, 圆形12针插头&5P插座		
	IP-028	适用贝达压力传感器电缆, L:12ft, 圆形12针插头&7孔插座		
	IP-029	适用飞利浦压力传感器电缆, L:12ft, 圆形12针插头&4孔插座		
	IP-030	适用MAXXIM压力传感器电缆, L:12ft, 圆形12针插头&5P插座		



本公司所有网站, 彩页所涉及到的图片, 文件, 商标, 版权均属于原作者, 本处出于产品说明需要而引用, 绝无它用

公司官方网站 : <http://www.touch-sz.com>

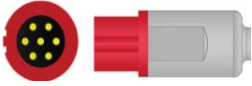

# 有创血压传感器电缆

## Invasive Pressure Transducers cable

兼容品牌 Manufacture	产品编号 P/N	产品描述 Product description	兼容型号 Compatibility	仪器端插头 Interface
西门子 SIEMENS	IP-031	适用雅培压力传感器电缆, L:12ft, 圆形10针插头&6P6C母座		
	IP-032	适用尤它压力传感器电缆, L:12ft, 圆形10针插头&4P母座		
	IP-033	适用爱德华压力传感器电缆, L:12ft, 圆形10针插头&5P插座		
	IP-034	适用贝达压力传感器电缆, L:12ft, 圆形10针插头&7孔插座		
	IP-035	适用飞利浦压力传感器电缆, L:12ft, 圆形10针插头&4孔插座		
	IP-036	适用MAXXIM压力传感器电缆, L:12ft, 圆形10针插头&5P插座		
西门子 SIEMENS DRAGER	IP-037	适用雅培压力传感器电缆, L:12ft, 圆形7针插头&6P6C母座		
	IP-038	适用尤它压力传感器电缆, L:12ft, 圆形7针插头&4P母座		
	IP-039	适用爱德华压力传感器电缆, L:12ft, 圆形7针插头&5P插座		
	IP-040	适用贝达压力传感器电缆, L:12ft, 圆形7针插头&7孔插座		
	IP-041	适用飞利浦压力传感器电缆, L:12ft, 圆形7针插头&4孔插座		
	IP-042	适用MAXXIM压力传感器电缆, L:12ft, 圆形7针插头&5P插座		
太空医疗 SPACELABS	IP-043	适用雅培压力传感器电缆, L:12ft, 圆形7针插头&6P6C母座		
	IP-044	适用尤它压力传感器电缆, L:12ft, 圆形7针插头&4P母座		
	IP-045	适用爱德华压力传感器电缆, L:12ft, 圆形7针插头&5P插座		

本公司所有网站, 彩页所涉及到的图片, 文件, 商标, 版权均属于原作者, 本处出于产品说明需要而引用, 绝无它用

公司官方网站 : <http://www.touch-sz.com>



# 有创血压传感器电缆

## Invasive Pressure Transducers cable

兼容品牌 Manufacture	产品编号 P/N	产品描述 Product description	兼容型号 Compatibility	仪器端插头 Interface
太空医疗 SPACELABS	IP-046	适用贝达压力传感器电缆, L:12ft, 圆形7针插头&7孔插座		
	IP-047	适用飞利浦压力传感器电缆, L:12ft, 圆形7针插头&4孔插座		
	IP-048	适用MAXXIM压力传感器电缆, L:12ft, 圆形7针插头&5P插座		



## 有创血压传感器 Invasive Pressure Transducers



产品描述:压力传感器套件  
仪器端插头:飞利浦4P  
产品编号:IP-049



产品描述:压力传感器套件  
仪器端插头:MAXXIM  
产品编号:IP-050



产品描述:压力传感器套件  
仪器端插头:雅培/美戴950 6P6C  
产品编号:IP-051



产品描述:压力传感器套件  
仪器端插头:尤它4P  
产品编号:IP-052



产品描述:压力传感器套件  
仪器端插头:贝达(BD)/欧美达  
产品编号:IP-053



产品描述:压力传感器套件  
仪器端插头:爱德华6P/百斯特  
产品编号:IP-054

本公司所有网站,彩页所涉及到的图片,文件,商标,版权均属于原作者,本处出于产品说明需要而引用,绝无它用

公司官方网站 :<http://www.touch-sz.com>



# 医用温度探头

## Medical Temperature probe



### 仪器端插头

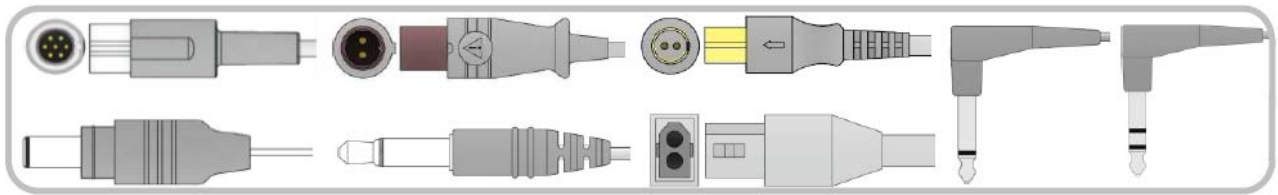

### 探头端连接器

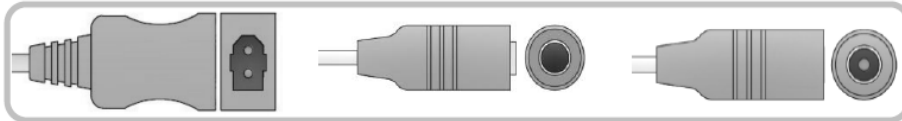

### 温度探头类型

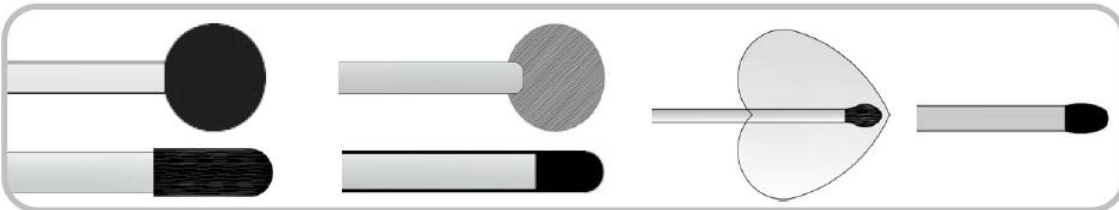



# 医用温度探头

## Medical Temperature probe

兼容品牌 Manufacturer	产品编号 P/N	产品描述 Product description	兼容仪器型号 Compatibility	仪器端插头 Interface	
飞利浦 PHILIPS 马葵 GE	MT-001	成人体表温度探头, 3.0米, 6.35单声道插头&12mm表盘, 25°C 2.252K Ω	飞利浦:A3系列监护仪, M3926A, M3927A, M3928A, M3929A 马葵:7000/7010, GE Eagle, Solar, Tram, Tramscope		
	MT-002	成人口腔, 直肠温度探头, 3.0米, 6.35单声道插头&4.7mm, 25°C 2.252K Ω			
	MT-003	儿童体表温度探头, 3.0米, 6.35单声道插头&5.6mm, 25°C 2.252K Ω			
	MT-004	儿童口腔, 直肠温度探头, 3.0米, 6.35单声道插头&3.0mm, 25°C 2.252K Ω			
科瑞康	MT-005	成人体表温度探头, 3.0米, 2针塑料插头&12mm表盘, 25°C 10K Ω	PC-1000, 5000, 9000, UP-6000		
	MT-006	成人体温温度探头, 3.0米, 2针塑料插头&4.7mm, 25°C 10K Ω			
迈瑞 MINDRAY	MT-007	成人体表温度探头, 3.0米, 圆形2针插头&12mm表盘, 25°C 2.252K Ω	PM6800监护系列		
	MT-008	成人口腔, 直肠温度探头, 3.0米, 圆形2针插头&4.7mm, 25°C 2.252K Ω			
	MT-009	儿童体表温度探头, 3.0米, 圆形2针插头&5.6mm表盘, 25°C 2.252K Ω			
	MT-010	儿童口腔, 直肠温度探头, 3.0米, 圆形2针插头&3.0mm, 25°C 2.252K Ω			
	MT-011	成人体表温度探头, 3.0米, 圆形2针插头&12mm表盘, 25°C 2.252K Ω			





本公司所有网站, 彩页所涉及到的图片, 文件, 商标, 版权均属于原作者, 本处出于产品说明需要而引用, 绝无它用

公司官方网站 :<http://www.touch-sz.com>

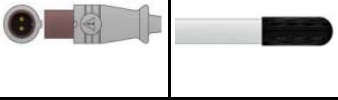
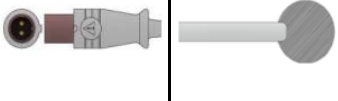
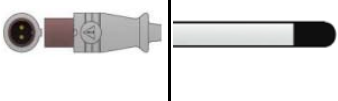

# 医用温度探头

## Medical Temperature probe

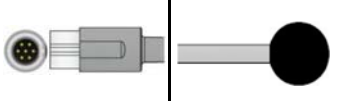
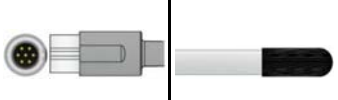
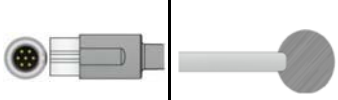
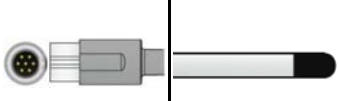
飞利浦 PHILIPS	MT-012	成人口腔，直肠温度探头，3.0米，圆形2针插头&4.7mm，25°C 2.252KΩ	飞利浦2针插座的模块通用	
	MT-013	儿童体表温度探头，3.0米，圆形2针插头&5.6mm表盘，25°C 2.252KΩ		
	MT-014	儿童口腔，直肠温度探头，3.0米，圆形2针插头&3.0mm，25°C 2.252KΩ		
丹麦阿堤玛	MT-015	成人体表温度探头，3.0米，圆形10孔插头&12mm表盘，25°C 2.252KΩ	DIASCOPE G2	
	MT-016	成人口腔，直肠温度探头，3.0米，圆形10孔插头&4.7mm，25°C 2.252KΩ		
	MT-017	儿童体表温度探头，3.0米，圆形10孔插头&5.6mm表盘，25°C 2.252KΩ		
	MT-018	儿童口腔，直肠温度探头，3.0米，圆形10孔插头&3.0mm，25°C 2.252KΩ		
西门子 SIEMENS MEDICAL	MT-019	成人体表温度探头，3.0米，圆形17针插头&12mm表盘，25°C 2.252KΩ	SC6002XL, SC7000, SC8000, SC9000XL	
	MT-020	成人口腔，直肠温度探头，3.0米，圆形7针插头&4.7mm，25°C 2.252KΩ		
	MT-021	儿童体表温度探头，3.0米，圆形7针插头&5.6mm表盘，25°C 2.252KΩ		
西门子 SIEMENS MEDICAL	MT-022	儿童口腔，直肠温度探头，3.0米，圆形7针插头&3.0mm，25°C 2.252KΩ	SC6002XL, SC7000, SC8000, SC9000XL	









本公司所有网站，彩页所涉及到的图片，文件，商标，版权均属于原作者，本处出于产品说明需要而引用，绝无它用  
公司官方网站：<http://www.touch-sz.com>

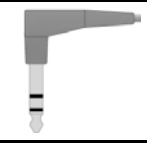
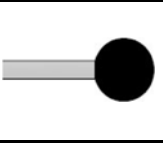
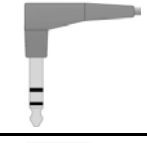

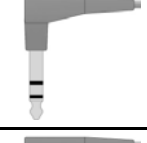
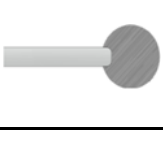
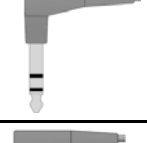
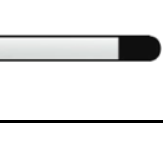
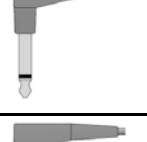
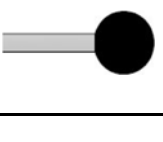
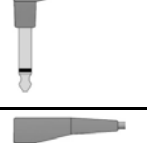

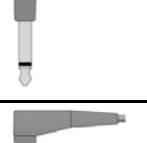
# 医用温度探头

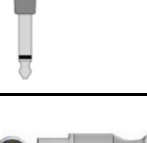
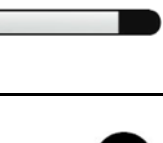
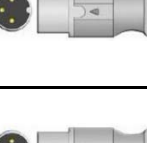
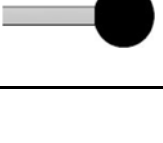
## Medical Temperature probe

太空 马葵 迈瑞	MT-023	成人体表温度探头, 3.0米, 6.35 立体声插头&12mm表盘, 25℃30K Ω	太空:700-0031- 00, 马葵:7000/7010 迈瑞:T8		
	MT-024	成人口腔, 直肠温度探头, 10ft (3.0米), 6.35立体声插头 &4.7mm, 25℃30K Ω			
	MT-025	儿童体表温度探头, 3.0米, 6.35 立体声插头&5.6mm表盘, 25℃30K Ω			
	MT-026	儿童口腔, 直肠温度探头, 3.0 米, 6.35立体声插头&3.0mm, 25℃ 30K Ω			
天荣 安科 科曼	MT-027	成人体表温度探头, 3.0米, 6.35 单声道插头&12mm表盘, 25℃10K Ω	C-100		
	MT-028	成人口腔, 直肠温度探头, 3.0 米, 6.35单声道插头&4.7mm, 25℃ 10K Ω			
	MT-029	儿童体表温度探头, 3.0米, 6.35 单声道插头&5.6mm表盘, 25℃10K Ω			
	MT-030	儿童口腔, 直肠温度探头, 3.0 米, 6.35单声道插头&3.0mm, 25℃ 10K Ω			
AIR SHIELDS	MT-031	成人体表温度探头, 3.0米, DIN3M 插头&12mm表盘, 25℃6.86K Ω	C-100		
	MT-032	成人口腔, 直肠温度探头, 3.0 米, DIN3M插头4.7mm, 25℃6.86K Ω			



# 无创血压袖带

## Non Invasive Blood Pressure Cuff

兼容品牌 Manufacture	产品编号 P/N	产品描述 Product description	兼容型号 Compatibility	仪器端插头 Interface
飞利浦 PHILIPS 科林 太空 伟伦 西门子 迈瑞 金科威 科瑞康	NB-001	可重复性使用无囊单管血压袖带, 成人 大腿, 单管, 周长: 42-50CM	飞利浦 浦:78352A/C, 78354A/ C, M1008A/B, M1176A, M 1350B, M3000A, M3001A ; 科林:Datascope- Passport, Acutor; 福田:Denshi; 太空:all, 伟 伦:Models-with locking luer-type connector, Criticare ; 西门子:-with bayonet type connector;	
	NB-002	可重复性使用无囊单管血压袖带, 大成 人, 单管, 周长: 32-42CM		
	NB-003	可重复性使用无囊单管血压袖带, 成人, 单管, 周长: 28-35CM		
	NB-004	可重复性使用无囊单管血压袖带, 小成 人, 单管, 周长:24-32CM		
	NB-005	可重复性使用无囊单管血压袖带, 儿童, 单管, 周长:17-25CM		
	NB-006	可重复性使用无囊单管血压袖带, 婴儿, 单管, 周长:15-22CM		
	NB-007	可重复性使用无囊单管血压袖带, 新生 儿, 单管, 周长:6-11CM		
飞利浦 PHILIPS 科林 太空 伟伦 西门子 迈瑞 金科威 科瑞康	NB-008	可重复性使用有囊单管血压袖带, 成人 大腿, 单管, 周长: 42-50CM	飞利浦 浦:78352A/C, 78354A/ C, M1008A/B, M1176A, M 1350B, M3000A, M3001A ; 科林:Datascope- Passport, Acutor; 福田:Denshi; 太空:all, 伟 伦:Models-with locking luer-type connector, Criticare ; 西门子:-with bayonet type connector;	
	NB-009	可重复性使用有囊单管血压袖带, 大成 人, 单管, 周长: 32-42CM		
	NB-010	可重复性使用有囊单管血压袖带, 成人, 单管, 周长: 28-35CM		
	NB-011	可重复性使用有囊单管血压袖带, 小成 人, 单管, 周长:24-32CM		
	NB-012	可重复性使用有囊单管血压袖带, 儿童, 单管, 周长:17-25CM		
	NB-013	可重复性使用有囊单管血压袖带, 婴儿, 单管, 周长:15-22CM		
	NB-014	可重复性使用有囊单管血压袖带, 新生 儿, 单管, 周长:6-11CM		
	NB-015	可重复性使用有囊双管血压袖带, 成人 大腿, 单管, 周长: 42-50CM		

本公司所有网站, 彩页所涉及到的图片, 文件, 商标, 版权均属于原作者, 本处出于产品说明需要而引用, 绝无它用

公司官方网站 : <http://www.touch-sz.com>



# 无创血压袖带

## Non Invasive Blood Pressure Cuff

兼容品牌 Manufacture	产品编号 P/N	产品描述 Product description	兼容型号 Compatibility	仪器端插头 Interface
通用医疗 德恩 欧美达 新伟伦	NB-016	可重复性使用无囊双管血压袖带, 大成人, 单管, 周长: 32-42CM	Dinama plus, XL, SX/XP. 8100 系列, Each GE corometrics; Critikon; 德恩欧美达: CAS; 新伟伦: vital signs models with threaded type Critikon style connector	
	NB-017	可重复性使用无囊双管血压袖带, 成人, 单管, 周长: 28-35CM		
	NB-018	可重复性使用无囊双管血压袖带, 小成人, 单管, 周长: 24-32CM		
	NB-019	可重复性使用无囊双管血压袖带, 儿童, 单管, 周长: 17-25CM		
	NB-020	可重复性使用无囊双管血压袖带, 婴儿, 单管, 周长: 15-22CM		
	NB-021	可重复性使用无囊双管血压袖带, 新生儿, 单管, 周长: 6-11CM		
通用医疗 德恩 欧美达 新伟伦	NB-022	可重复性使用有囊双管血压袖带, 大成人, 单管, 周长: 32-42CM	Dinama plus, XL, SX/XP. 8100 系列, Each GE corometrics; Critikon; 德恩欧美达: CAS; 新伟伦: vital signs models with threaded type Critikon style connector	
	NB-023	可重复性使用有囊双管血压袖带, 成人, 单管, 周长: 28-35CM		
	NB-024	可重复性使用有囊双管血压袖带, 小成人, 单管, 周长: 24-32CM		
	NB-025	可重复性使用有囊双管血压袖带, 儿童, 单管, 周长: 17-25CM		
	NB-026	可重复性使用有囊双管血压袖带, 婴儿, 单管, 周长: 15-22CM		
	NB-027	可重复性使用有囊双管血压袖带, 新生儿, 单管, 周长: 6-11CM		



# 连接管 Tubes

兼容品牌 Manufacturer	产品编号 P/N	产品描述 Product description	兼容仪器型号 Compatibility	仪器端插头 Interface	
COLIN CRITICARE CSI DATASCOPE NIHONKOHDEN DATASCOPE	TU-001	血压袖带连接管, 单管, 适用于成人和儿童, 3.0m	通用		
	TU-002	血压袖带连接管, 单管, 适用于成人和儿童, 3.0m			
	TU-003	血压袖带连接管, 单管, 适用于成人和儿童, 3.0m			
	TU-004	血压袖带连接管, 单管, 适用于成人和儿童, 3.0m			
CREATIVE NEUSOFT JETEEM	TU-005	血压袖带连接管, 单管, 适用于成人和儿童, 3.0m	CREATIVE NEUSOFT JETEEM		
DRAGE	TU-006	兼容德尔格血压袖带连接管, 单管, 适用于成人和儿童, 2.4m	Drager:SC6000- 7000/8000/9000 Infinity		
	TU-007	兼容德尔格血压袖带连接管, 单管, 适用于成人和儿童, 2.4m			
MEK GOLDWAY	TU-008	血压袖带连接管, 单管, 适用于成人和儿童, 3.6m	MEK:MP700, MP1000, GOLDWAY		
	TU-009	血压袖带连接管, 单管, 适用于成人和儿童, 3.6m			
DINAMAP	TU-010	血压袖带连接管, 双管, 适用于成人和儿童, 3.6m	DINAMAP:Pro, Co mpact MPS Series		
	TU-011	血压袖带连接管, 双管, 适用于新生儿, 3.6m			

本公司所有网站, 彩页所涉及到的图片, 文件, 商标, 版权均属于原作者, 本处出于产品说明需要而引用, 绝无它用

公司官方网站 :<http://www.touch-sz.com>



## 连接管 Tubes

DINAMAP	TU-012	血压袖带连接管，双管，适用于成人和儿童，3.0m	DINAMAP:Pro, Compact, MPS, Series		
GE-MARQUETTE	TU-013	血压袖带连接管，双管，适用于成人和儿童，3.6m	GE-marquette: Eagle3000, Dash 2000/3000/4000 Tram400/450/451, Tram800/850/851 Corometrics 120		
	TU-014	血压袖带连接管，单管，适用于成人和儿童，3.6m			
	TU-015	血压袖带连接管，单管，适用于新生儿，2.4m			
DINAMAP GE CRITIKON KONTRON INVIO	TU-016	血压袖带连接管，双管，适用于成人和儿童，3.6m	DINAMAP 1846, 8100, 9300 AND PLUS Series Monitors GE medical Critikon Kontron Invivo		
	TU-017	血压袖带连接管，双管，适用于成人和儿童，2.4m			
	TU-018	血压袖带连接管，双管，适用于新生儿，3.6m			
GE MEDICAL COROMETRICS GE DATEX	TU-019	血压袖带连接管，双管，适用于成人和儿童，3.6m	Eagle 4000, Tram 100/200/300/350, Corometrics 120, GE medical Corometrics GE Datex		
	TU-020	血压袖带连接管，双管，适用于成人和儿童，3.6m			
	TU-021	血压袖带连接管，双管，适用于新生儿，2.4m			
	TU-022	血压袖带连接管，单管，3.0m			

本公司所有网站，彩页所涉及到的图片，文件，商标，版权均属于原作者，本处出于产品说明需要而引用，绝无它用  
公司官方网站：<http://www.touch-sz.com>



## 连接管 Tubes

PHILIPS SIMENS MINDRAY SPACELABS MEK NPB GOLDWAY	TU-023	血压袖带连接管, 单管, 3.0m	Philips Simens Mindray Spacelabs MEK NPB Goldway 40101X, M45xx, M 157x series pressure cuffs, Use with Philips Instrument: A1/ A3, M3921A, M392 3A, M3926A, M392 7A, M3928A, M392		
	TU-024	血压袖带连接管, 单管, 3.0m			
	TU-025	血压袖带连接管, 单管, 3.0m			
CREATIVE NEUSOFT JETEEM	TU-026	塑料自锁气管插头, 适配气管内径 4mm	通用		
	TU-027	塑料自锁气管插座, 适配气管内径 4mm			
ALL	TU-028	管对管气管接头, 塑料, 适配气管内 径4mm, 另一端2.5mm	ALL		
	TU-029	滑入式气管母接头, 黄铜镀镍, 适 配气管内径4mm			
	TU-030	滑入式气管公接头, 黄铜镀镍, 适 配气管内径4mm			
PHILIPS SIMENS DATASCOPE COLIN GOLDWAY	TU-031	弹簧自锁式袖带公接头, 黄铜镀 镍, 适配气管内径4mm	PHILIPS SIMENS DATASCOPE COLIN GOLDWAY		
	TU-032	弹簧自锁式袖带公接头, 塑料, 适 配气管内径2.5-4mm			
	TU-033	弹簧自锁式袖带公接头, 黄铜镀 镍, 适配气管内径2.5-4mm			

本公司所有网站, 彩页所涉及到的图片, 文件, 商标, 版权均属于原作者, 本处出于产品说明需要而引用, 绝无它用  
公司官方网站 : <http://www.touch-sz.com>



## 连接管 Tubes

SPACELABS DATASCOPE COLIN	TU-034	(Plactic Luer Lock) 螺旋式母接头, 塑料, 适配气管内径2.5-4mm	SPACELABS DATASCOPE COLIN	
	TU-035	(Plactic Luer Lock) 螺旋式母接头, 塑料, 适配气管内径2.5-4mm		
GE DINAMAP	TU-036	螺旋式母接头, 塑料, 适配气管内径2.5-4mm	GE Dinamap	
	TU-037	螺旋式母接头, 塑料, 适配气管内径2.5-4mm		
GE-MARQUETTE PROTOCOL DATEX-OHMEDA	TU-038	(Quick Disconnect Locking type) 快速锁扣式母接头, 塑料, 适配气管内径2.5-4mm	GE-Marquette Protocol Datex-Ohmeda	
	TU-039	(Quick Disconnect Locking type) 快速锁扣式母接头, 塑料, 适配气管内径2.5-4mm		
GE-MARQUETTE	TU-040	自锁式母接头, 塑料, 适配气管内径2.5-4mm	Marquette one- tube systems	
	TU-041	自锁式母接头, 塑料, 适配气管内径2.5-4mm		
EAGLE	TU-042	滑入式双管母接头(2管相通), 塑料, 适配气管内径4mm	Eagle3000, Dash 2000/3000/4000 , Tram400/450/4 51/800/850/851	
	TU-043	四通气管接头, 塑料, 适配气管内径4mm		
	TU-044	滑入式双管母接头(2管相通), 塑料, 适配气管内径4mm		

本公司所有网站, 彩页所涉及到的图片, 文件, 商标, 版权均属于原作者, 本处出于产品说明需要而引用, 绝无它用  
公司官方网站 : <http://www.touch-sz.com>



## 连接管 Tubes

PHILIPS GOLDWAY	TU-045	弹簧自锁式公接座, L:29mm, 黄铜镀镍, 适配气管内径4mm	PHILIPS GOLDWAY	
	TU-046	弹簧自锁式公接座, L:38mm, 黄铜镀镍, 适配气管内径4mm		
	TU-047	弹簧自锁式母接座, 黄铜镀镍, 适配气管内径2.5-4mm		
	TU-048	滑入式母接头, 金属, 适配气管内径4mm		
EAGLE	TU-049	圆形双路气管接头, 塑料, 适配气管内径4mm	Eagle4000, Tram 100/200/300/350 Corometrics 118	
	TU-050	方形两孔气管接头, 塑料, 适配气管内径4mm	Eagle3000, Dash 2000/3000/4000 , Tram400/450/451/800/850/851	
DINAMAP	TU-051	灰色外套双气管接头, 塑料, 适配气管内径4mm	DINAMAP, Pro, Compact, MPS Series	





# 心电电极

## ECG Electrodes

兼容品牌 Manufacture	产品编号 P/N	产品描述 Product description	产品图 Product draw
适用于所有 心电监护, 遥感心电记 录, 心电工 作站心电测 试	EE-001	一次性儿童心电电极, 棉坊布背衬, 直径4.0mm, 湿胶, 扣式电极, 氯化银传感器, 1000PCS/1包	
	EE-002	一次性成人电电极, 棉坊布背衬, 直径5.0mm, 湿胶, 扣式电极, 氯化银传感器, 1000PCS/1包	
适用于所有 心电工作站	EE-003	成人吸球电极 -适合于3.0mm插针和4.0mm香蕉插的导联线连接 -不含乳胶 -电极直径21mm, 吸球直径26mm -电极材质: 铜镀镍	
	EE-004	儿童吸球电极 -适合于3.0mm插针香蕉插的导联线连接 -不含乳胶 -电极直径17mm, 吸球直径23mm -电极材质: 铜镀镍	
	EE-005	儿童吸球电极 -适合于3.0mm插针的导联线连接 -不含乳胶 -电极直径17mm, 吸球直径23mm -电极材质: 铜镀镍	
	EE-006	儿童吸球电极 -适合于4.0mm香蕉插头的导联线连接 -不含乳胶 -电极直径17mm, 吸球直径23mm -电极材质: 铜镀镍	
	EE-007	儿童多功能吸球电极 -适合于3.0mm插针, 4.0mm香蕉插, 4.0mm按扣的导联线连接 -不含乳胶 -电极直径17mm, 吸球容量2cc, 吸球直径23mm -电极材质: 铜镀镍/氯化银	
	EE-008	成人肢体夹电极, IEC -适合与3.0mm插针的导联线连接 -电极材质: 铜镀镍 -包装: 4pcs/盒 -颜色: 红(R), 黄(L), 黑(RF), 绿(F)	
	EE-009	成人肢体夹电极, IEC -适合与4.0mm插针的导联线连接 -电极材质: 铜镀镍 -包装: 4pcs/盒 -颜色: 红(R), 黄(L), 黑(RF), 绿(F)	

本公司所有网站, 彩页所涉及到的图片, 文件, 商标, 版权均属于原作者, 本处出于产品说明需要而引用, 绝无它用



# 心电电极









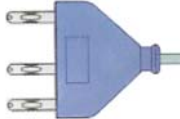

## ECG Electrodes

兼容品牌 Manufacture	产品编号 P/N	产品描述 Product description	产品图 Product draw
	EE-010	儿童肢体夹电极, AHA -适合与3.0mm插针的导联线连接 -电极材质:铜镀镍 -包装: 4pcs/盒 -颜色: 黑(LA), 白(RA), 红(LL), 绿(RL)	
	EE-011	儿童肢体夹电极, AHA -适合与4.0mm香蕉插头的导联线连接 -电极材质:铜镀镍 -包装: 4pcs/盒 -颜色: 黑(LA), 白(RA), 红(LL), 绿(RL)	
适用于所有 心电工作站	EE-012	成人多功能肢体夹电极, IEC -适合与3.0mm插针, 4.0mm香蕉插头, 4.0mm按扣和夹子的导联线连接 -电极材质:铜镀镍 -包装: 4pcs/盒 -颜色: 红(R), 黄(L), 黑(RF), 绿(F)	
	EE-013	成人多功能肢体夹电极, AHA -适合与3.0mm插针, 4.0mm香蕉插头, 4.0mm按扣和夹子的导联线连接 -电极材质:铜镀镍 -包装: 4pcs/盒 -颜色: 白(RA), 黑(LA), 绿(RL), 红(LL)	
	EE-014	儿童多功能肢体夹电极, IEC -适合与3.0mm插针, 4.0mm香蕉插头, 4.0mm按扣和夹子的导联线连接 -电极材质:铜镀镍 -包装: 4pcs/盒 -颜色: 红(R), 黄(L), 黑(RF), 绿(F)	
	EE-015	儿童多功能肢体夹电极, AHA -适合与3.0mm插针, 4.0mm香蕉插头, 4.0mm按扣和夹子的导联线连接 -电极材质:铜镀镍 -包装: 4pcs/盒 -颜色: 白(RA), 黑(LA), 绿(RL), 红(LL)	

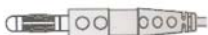

# 高频电刀笔与连接线

ESU pencil Connecting cable for electrosurgery

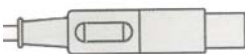
兼容品牌 Manufacturer	产品编号 P/N	产品描述 Product description	仪器端插头 Interface	仪器端插头 Interface
高频手术设备	ES-001	一次性高频电刀操控笔, 规格:40mm标准刀头, 线长: 2.8m		
	ES-002	重复性高频电刀操控笔, 规格:40mm标准刀头, 线长: 2.8m		
	ES-003	可重复性使用脚控电刀操控笔, 规格:40mm标准刀头, 线长: 2.8m		
高频手术设备 连接线	ES-004	欧式双极电凝钳电缆, 规格:3m, 连接器:2*4.0mm香蕉插头&欧式钳 子连线		
	ES-005	双极电刀电缆, 规格:3m, 连接器:2*4.0mm香蕉插头&美式插 头		
	ES-006	电外壳手术设备连接线, 规格:4m, 连接器:7.9单声道插头&3.0铜管		
	ES-007	双极电刀电缆, 规格:3m, 连接器:2*4.0mm香蕉插头&欧式插 头	